

**Pioneer** *sound.vision.soul*

DVD Recorder

# DVR-330-S



Operating Instructions

**RW**  
COMPATIBLE

# IMPORTANT



The lightning flash with arrowhead symbol, within an equilateral triangle, is intended to alert the user to the presence of uninsulated "dangerous voltage" within the product's enclosure that may be of sufficient magnitude to constitute a risk of electric shock to persons.

## CAUTION

**RISK OF ELECTRIC SHOCK  
DO NOT OPEN**

### CAUTION:

TO PREVENT THE RISK OF ELECTRIC SHOCK, DO NOT REMOVE COVER (OR BACK). NO USER-SERVICEABLE PARTS INSIDE. REFER SERVICING TO QUALIFIED SERVICE PERSONNEL.



The exclamation point within an equilateral triangle is intended to alert the user to the presence of important operating and maintenance (servicing) instructions in the literature accompanying the appliance.

D3-4-2-1-1\_En-A

## WARNING

**This equipment is not waterproof. To prevent a fire or shock hazard, do not place any container filled with liquid near this equipment (such as a vase or flower pot) or expose it to dripping, splashing, rain or moisture.**

D3-4-2-1-3\_A\_En

## WARNING

*Before plugging in for the first time, read the following section carefully.*

**The voltage of the available power supply differs according to country or region. Be sure that the power supply voltage of the area where this unit will be used meets the required voltage (e.g., 230V or 120V) written on the rear panel.**

D3-4-2-1-4\_A\_En

## CAUTION

This product is a class 1 laser product, but this product contains a laser diode higher than Class 1. To ensure continued safety, do not remove any covers or attempt to gain access to the inside of the product. Refer all servicing to qualified personnel.

**CLASS 1 LASER PRODUCT  
LASER KLASSE 1  
クラス1レーザー製品**

The following caution label appears on your unit.  
Location: inside of the unit

**CAUTION** CLASS 3B VISIBLE AND INVISIBLE LASER RADIATION WHEN OPEN, AVOID EXPOSURE TO THE BEAM.  
**ATTENTION** RADIATIONS LASER VISIBLES ET INVISIBLES DE CLASSE 3B QUAND OUVERT. ÉVITEZ TOUT EXPOSITION AU FAISCEAU.  
**ADVARSEL** KLASSE 3B SYNLIG OG USYNLIG LASERSTRÅLING VED ÅBNING. UNDGÅ UDSÆTTELSE FOR STRÅLING.  
**VARNING** KLASSE 3B SYNLIG OCH OSYNLIG LASERSTRÅLNING NÄR DENNA DEL ÄR ÖPPNAD. UNDVIK ATT UTSÄTTA DIG FÖR STRÅLEN.  
**VORSICHT** BEI GEÖFFNETER ABDECKUNG IST SICHTBARE UND UNSICHTBARE LASERSTRÄHLUNG DER KLASSE 3B IM GERÄTEINNEREN VORHANDEN. AUGEN NICHT DEM LASERSTRAHL AUSSETZEN!  
**PRECAUCIÓN** CUANDO SE ABRE HAY RADIACIÓN LASER DE CLASE 3B VISIBLE E INVISIBLE. EVITE LA EXPOSICIÓN A LOS RAYOS LÁSER.  
**VARO!** AVATTAESSA OLET ALLTIINA NÄKYVÄLLE JA NÄKYMÄTTÖMÄLLE LUOKAN 3B LASERSÄTEILYLLE. ÄLÄ KATSO SÄTEESEEN.  
**注意** ここを開くと CLASS 3B の可視レーザー光及び不可視レーザー光が出ます。ビームを直接見たり、触れたりしないこと。

DRW2247 - A

D3-4-2-1-8\_A\_En

## CAUTION

The STANDBY/ON switch on this unit will not completely shut off all power from the AC outlet. Since the power cord serves as the main disconnect device for the unit, you will need to unplug it from the AC outlet to shut down all power. Therefore, make sure the unit has been installed so that the power cord can be easily unplugged from the AC outlet in case of an accident. To avoid fire hazard, the power cord should also be unplugged from the AC outlet when left unused for a long period of time (for example, when on vacation).

D3-4-2-2a\_A\_En

## WARNING

**To prevent a fire hazard, do not place any naked flame sources (such as a lighted candle) on the equipment.**

D3-4-2-1-7a\_A\_En

## Operating Environment

Operating environment temperature and humidity:  
+5 °C – +35 °C (+41 °F – +95 °F); less than 85 %RH  
(cooling vents not blocked)

Do not install this unit in a poorly ventilated area, or in locations exposed to high humidity or direct sunlight (or strong artificial light)

D3-4-2-1-7c\_A\_En

## VENTILATION CAUTION

**When installing this unit, make sure to leave space around the unit for ventilation to improve heat radiation (at least 10 cm at top, 10 cm at rear, and 10 cm at each side).**

## WARNING

**Slots and openings in the cabinet are provided for ventilation to ensure reliable operation of the product, and to protect it from overheating. To prevent fire hazard, the openings should never be blocked or covered with items (such as newspapers, table-cloths, curtains) or by operating the equipment on thick carpet or a bed.**

D3-4-2-1-7b\_A\_En

This product incorporates copyright protection technology that is protected by method claims of certain U.S. patents and other intellectual property rights owned by Macrovision Corporation and other rights owners. Use of this copyright protection technology must be authorized by Macrovision Corporation, and is intended for home and other limited viewing uses only unless otherwise authorized by Macrovision Corporation. Reverse engineering or disassembly is prohibited.

This product is for general household purposes. Any failure due to use for other than household purposes (such as long-term use for business purposes in a restaurant or use in a car or ship) and which requires repair will be charged for even during the warranty period.

K041\_En

This product includes FontAvenue® fonts licenced by NEC corporation. FontAvenue is a registered trademark of NEC Corporation.

## POWER-CORD CAUTION

Handle the power cord by the plug. Do not pull out the plug by tugging the cord and never touch the power cord when your hands are wet as this could cause a short circuit or electric shock. Do not place the unit, a piece of furniture, etc., on the power cord, or pinch the cord. Never make a knot in the cord or tie it with other cords. The power cords should be routed such that they are not likely to be stepped on. A damaged power cord can cause a fire or give you an electrical shock. Check the power cord once in a while. When you find it damaged, ask your nearest PIONEER authorized service center or your dealer for a replacement.

5002\_En

# Contents

## 01 Before you start

Features	6
What's in the box	8
Putting the batteries in the remote control	8
Using the remote control	8
Disc / content format playback compatibility	9

## 02 Connecting up

Rear panel connections	12
Front panel connections	12
Easy connections	13
Using other types of video output	14
Connecting to a cable box or satellite receiver (1)	15
Connecting to a cable box or satellite receiver (2)	16
Connecting to an AV amplifier or receiver	17
Connecting other AV sources	18
Plugging in	18

## 03 Controls and displays

Front panel	19
Remote control	20
Display	22

## 04 Getting started

Switching on and setting up	23
Making your first recording	25
Using the built-in TV tuner	26
Basic playback	27
Using the Home Menu	29
Displaying disc information on-screen	30

## 05 Recording

About DVD recording	32
Recording time and picture quality	32
Recorded audio	33
Restrictions on video recording	33
Setting the picture quality/recording time	33
Basic recording from the TV	34
Setting a timer recording	34
Timer recording FAQ	40
Simultaneous recording and playback	40
Recording from an external component	41
Automatic recording from a satellite tuner	42
Recording from a DV camcorder	42
Playing your recordings on other DVD players	44
Initializing a recordable DVD disc	45

## 06 Playback

Introduction	46
Navigating discs	46
Using the Disc Navigator to browse the contents of a disc	47
Scanning discs	48
Playing in slow motion	49
Frame advance/frame reverse	49
The Play Mode menu	49
Displaying and switching subtitles	52
Switching DVD soundtracks	52
Switching audio channels	53
Switching camera angles	53

## 07 Editing

The Disc Navigator screen	54
Command menu panel options	55

## 08 The PhotoViewer

Playing a slideshow	61
---------------------	----

## 09 The Disc Setup menu

Introduction	63
Basic settings	63
Initialize settings	64
Finalize settings	64

## 10 The Video/Audio Adjust menu

Setting the picture quality for TV and external inputs	65
Setting the picture quality for disc playback	66
Audio DRC	67

## 11 The Initial Setup menu

Using the Initial Setup menu	68
------------------------------	----



## **12 Additional information**

Resetting the recorder.....	<b>75</b>
Setting up the remote to control your TV .....	<b>75</b>
Screen sizes and disc formats .....	<b>76</b>
Troubleshooting.....	<b>77</b>
Frequently asked questions .....	<b>79</b>
About DV.....	<b>80</b>
Manual recording modes.....	<b>81</b>
Language code list.....	<b>82</b>
Country/Area code list .....	<b>82</b>
On-screen displays and recorder displays .....	<b>83</b>
Handling discs.....	<b>84</b>
Cleaning the pickup lens.....	<b>84</b>
Condensation .....	<b>84</b>
Hints on installation.....	<b>85</b>
Glossary.....	<b>85</b>
Specifications .....	<b>88</b>

## **Index**

## Chapter 1

# Before you start

### Features

- **Chase play** **VR mode** (DVD-RW only)

Using chase play you can start watching a recording from the beginning, while continuing to record. For example, you could set a timer recording for a program that you're going to miss the first 15 minutes of, then start watching while the recorder is still recording the program 15 minutes ahead of you.

- **Simultaneous recording and playback**

- **VR mode** (DVD-RW only)

This feature allows you to record a broadcast program while watching something else already recorded on the same disc.

- **On-screen Help**

Use the **HELP** button on the remote control to display a help screen for the current operation.

- **Disc Navigator**

The on-screen Disc Navigator makes finding your way around the contents of a disc easy. For recordable DVD content, moving thumbnail images are displayed for ease of use. The Disc Navigator is also where you can edit recordable DVD content.

- **Home Menu**

The Home Menu gives you on-screen access to all the recorder's features in one convenient place, from setting up the recorder, to programming a timer recording and editing a recording.

- **Progressive scan-compatible**

Compared to standard interlaced video, progressive scan effectively doubles the amount of video information fed to your TV or monitor. The result is a stable, flicker-free image. (Check your TV/monitor for compatibility with this feature.)

- **Cinema-style surround sound in your home**

Connect this recorder to a Dolby Digital and/or DTS-compatible AV amp/receiver to enjoy full surround sound effects from Dolby Digital and DTS DVD discs.

- **Easy Timer Recording**

Setting the recorder to record a program is simple from the Easy Timer Recording screen. Set the channel to record and the recording quality, then graphically set the start and end times of the recording. That's it!

- **Program up to 32 timer recordings**

You can program the recorder to record up to 32 programs, up to a month in advance, using the G-Code™ system\* for easy programming if you want. As well as single programs, you can specify daily or weekly recordings, too.

*\* G-Code is registered in at least the following countries: Australia, China, Hong Kong, Japan, New Zealand, South Korea, Taiwan and Singapore.*

*The G-Code system is manufactured under license from Gemstar Development Corporation.*

- **One Touch Recording**

Use One Touch Recording to start recording immediately in 30 minute blocks. Each time you press the **● REC** button, the recording time is extended by another 30 minutes, up to six hours.

- **Optimized recording**

Optimized recording adjusts the recording quality automatically if a timer recording will not fit onto a disc with the settings that you made.

- **Auto Start Recording from satellite receiver or other set top box**

With a satellite receiver or other set top box connected to the **INPUT 1/AUTO START REC** inputs of this recorder, you can start and stop recording automatically according to the timer settings of the set top box.

- **High quality 16-bit Linear PCM audio**

In the **LPCM** recording mode, audio is recorded in uncompressed 16-bit Linear PCM format. This delivers great sounding audio to accompany the high picture quality.

- **Picture quality adjustment features**

During playback, you can adjust various picture quality settings to improve the picture. You can also adjust the recording picture quality. For example, if you want to make a DVD copy of an old video tape, you can optimize the picture quality before transferring it to disc.

- **Find what you want to watch quickly and easily**

Unlike video tape that needs to be wound to the correct place, you can jump right to the part of a DVD disc that you want to watch. Search for a point on a disc by title, chapter or time.

- **Manual recording**

In addition to six preset recording quality modes, the manual recording mode allows you to access 33 different recording quality/time settings, giving you precise control over the recording.

- **Record from a DV camcorder**

This recorder has a built-in DV (Digital Video) input for connection to a DV camcorder. This makes it ideal for transferring camcorder footage to DVD for editing.

- **Safe, non-destructive editing** **VR mode**

When editing Play List content, the actual content of the disc (the Original content) is not touched. The edited version (the Play List content) just points to various parts of the Original content.

- **Play Video mode recordings on a regular DVD**

**player** **Video mode**

Discs recorded using the Video mode can be played back on regular DVD players, including computer DVD drives compatible with DVD-Video playback\*.

*\* 'DVD-Video format' recording: The use of the DVD-Video format for recording on DVD-R and DVD-RW discs is referred to as recording in 'Video mode' on Pioneer's DVD recorders. Supporting playback of DVD-R / DVD-RW discs is optional for manufacturers of DVD playback equipment, and there is DVD playback equipment that does not play DVD-R or DVD-RW discs recorded in the DVD-Video format.  
Note: 'Finalization' is required.*

- **WMA, MP3 and JPEG file playback**

This recorder can play WMA and MP3 audio files and JPEG picture files on CD-R/RW or CD-ROM discs. JPEG picture files can also be played from DVD-R/RW discs.

## What's in the box

Please confirm that the following accessories are in the box when you open it.

- Remote control
- AA/R6P dry cell batteries x2
- Audio/video cable (red/white/yellow)
- RF antenna cable
- Power cable
- These operating instructions

## Putting the batteries in the remote control

1 Open the battery compartment cover on the back of the remote control.

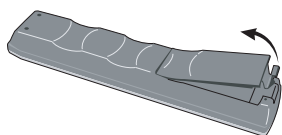

2 Insert two AA/R6P batteries into the battery compartment following the indications (+, -) inside the compartment.

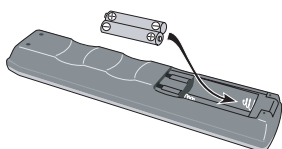

3 Close the cover.

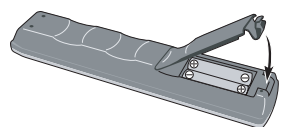

## Important

Incorrect use of batteries can result in hazards such as leakage and bursting. Please observe the following:

- Don't mix new and old batteries together.
- Don't use different kinds of batteries together—although they may look similar, different batteries may have different voltages.
- Make sure that the plus and minus ends of each battery match the indications in the battery compartment.
- Remove batteries from equipment that isn't going to be used for a month or more.
- When disposing of used batteries, please comply with governmental regulations or environmental public instruction's rules that apply in your country or area.

## Using the remote control

Please keep in mind the following when using the remote control:

- Make sure that there are no obstacles between the remote and the remote sensor on the unit.
- Remote operation may become unreliable if strong sunlight or fluorescent light is shining on the unit's remote sensor.
- Remote controllers for different devices can interfere with each other. Avoid using remotes for other equipment located close to this unit.
- Replace the batteries when you notice a fall off in the operating range of the remote.
- When the batteries run down or you change the batteries, the remote control mode and TV preset codes are automatically reset. See *Remote Control Mode* on page 73 and *Setting up the remote to control your TV* on page 75 to reset them.
- Use within the operating range in front of the remote control sensor on the front panel, as shown.

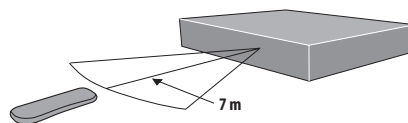

- You can control this recorder using the remote sensor of another Pioneer component using the **CONTROL IN** jack on the rear panel. See *Rear panel connections* on page 12 for more information.



## Disc / content format playback compatibility

### General disc compatibility

This recorder is compatible with a wide range of disc types (media) and formats. Playable discs will generally feature one of the following logos on the disc and/or disc packaging. Note however that some disc types, such as recordable CD and DVD, may be in an unplayable format—see below for further compatibility information.



- Also compatible with KODAK Picture CD
- **DVD** is a trademark of DVD Format/Logo Licensing Corporation.
-  is a trademark of Fuji Photo Film Co. Ltd.

This recorder also supports the IEC's Super VCD standard. Compared to the Video CD standard, Super VCD offers superior picture quality, and allows two soundtracks to be recorded. Super VCD also supports the widescreen size.



### DVD-R/RW compatibility

This recorder will play and record DVD-R/RW discs.

Compatible media:

- DVD-RW Ver. 1.1, Ver. 1.1 / 2x, Ver. 1.2 / 2–4x and Ver. 1.2 / 2–6x
- DVD-R Ver. 2.0 and Ver. 2.0 / 4x / 8x / 16x and Ver. 2.1 / 1–8x / 1–16x

Recording formats:

- DVD-R/RW: Video Recording (VR) format and DVD-Video format (Video mode)

Readable formats:

- DVD-R/RW: Video Recording (VR) format and DVD-Video format (Video mode)

Note that older models of DVD recorders and DVD writers may reject DVD-RW Ver. 1.2 discs and/or corrupt the data on the disc. If you want to share DVD-RW discs between this recorder and an older recorder/writer, we recommend using Ver. 1.1 discs.

The following table shows older Pioneer DVD recorders' limited compatibility with DVD-RW Ver. 1.2 discs.

Model	Playable	Recordable
DVR-7000	Yes <sup>1,2,3</sup>	No
DVR-310/ DVR-510H	Yes <sup>1</sup>	No

<sup>1</sup> Discs should be finalized in this recorder before playing. Unfinalized VR mode and Video mode discs may not play.

<sup>2</sup> **Cannot read the CPRM information will show in the display when you load a disc. However, this will not affect playback.**

<sup>3</sup> Copy-once protected disc titles will not play.

### CD-R/RW compatibility

This recorder cannot record CD-R or CD-RW discs.

- Readable formats: CD-Audio, Video CD/Super VCD, ISO 9660 CD-ROM\* containing MP3, WMA or JPEG files  
\* ISO 9660 Level 1 or 2 compliant. CD physical format: Mode1, Mode2 XA Form1. Romeo and Joliet file systems are both compatible with this recorder.
- Multi-session playback: Yes (except CD-Audio and Video CD/Super VCD)
- Unfinalized disc playback: CD-Audio only

### Compressed audio compatibility

- Compatible media: CD-ROM, CD-R, CD-RW
- Compatible formats: MPEG-1 Audio Layer 3 (MP3), Windows Media Audio (WMA)
- Sampling rates: 44.1 or 48kHz
- Bit-rates: Any (128Kbps or higher recommended)
- Variable bit-rate (VBR) MP3 playback: Yes
- VBR WMA playback: No
- WMA encoder compatibility: Windows Media Codec 8 (files encoded using Windows Media Codec 9 may be playable but some parts of the specification are not supported; specifically, Pro, Lossless, Voice and VBR)
- DRM (Digital Rights Management) file playback: No (see also DRM in the Glossary on page 85)
- File extensions: .mp3, .wma (these must be used for the recorder to recognize MP3 and WMA files – do not use for other file types)
- File structure: Up to 99 folders / 999 files (if these limits are exceeded, only files and folders up to these limits are playable)

## WMA (Windows Media Audio) compatibility



The Windows Media® logo printed on the box indicates that this recorder can playback Windows Media Audio content.

WMA is an acronym for Windows Media Audio and refers to an audio compression technology developed by Microsoft Corporation. WMA content can be encoded by using Windows Media® Player for Windows® XP, Windows Media® Player 9 or Windows Media® Player 10 series.

*Microsoft, Windows Media, and the Windows logo are trademarks, or registered trademarks of Microsoft Corporation in the United States and/or other countries.*

## JPEG file compatibility

- Compatible formats: Baseline JPEG and EXIF 2.2\* still image files  
\*File format used by digital still cameras
- Sampling ratio: 4:4:4, 4:2:2, 4:2:0
- Horizontal resolution: 160 – 5120 pixels
- Vertical resolution: 120 – 3840 pixels
- Progressive JPEG compatible: No
- File extensions: .jpg, .jpeg, .jif, .jfif (must be used for the recorder to recognize JPEG files – do not use for other file types)
- File structure: The recorder can load up to 99 folders / 999 files at one time (if there are more files/folders that this on the disc then more can be reloaded)

## PC-created disc compatibility

Discs recorded using a personal computer may not be playable in this unit due to the setting of the application software used to create the disc. In these particular instances, check with the software publisher for more detailed information.

Discs recorded in packet write mode (UDF format) are not compatible with this recorder.

Check the DVD-R/RW or CD-R/RW software disc boxes for additional compatibility information.

## Frequently asked questions

- *What's the difference between DVD-R and DVD-RW?*  
The most important difference between DVD-R and DVD-RW is that DVD-R is a record-once medium, while DVD-RW is a re-recordable/erasable medium. You can re-record/erase a DVD-RW disc approximately 1,000 times.  
For more information, see *About DVD recording* on page 32.
  - *What's VR mode?*  
VR (Video Recording) mode is a special mode designed for home DVD recording. It allows flexible editing of recorded material compared to 'Video mode'. On the other hand, Video mode discs are more compatible with other DVD players.
  - *How do I change the format of a disc?*  
Both DVD-R and DVD-RW discs can be initialized for Video mode or VR mode recording. DVD-R discs are ready for Video mode recording when you first load them into the recorder. You can, however, initialize them for VR mode recording from the Disc Setup menu.  
DVD-RW discs can be initialized and re-initialized for either mode at any time (although initializing will erase all the data on the disc).
  - *Can I play my recordable discs in a regular DVD player?*  
Generally, DVD-R discs and DVD-RW discs recorded in Video mode\* are playable in a standard DVD player, but they must be 'finalized' first. This process fixes the contents of the disc to make them readable to other DVD players as DVD-Video discs.  
DVD-R discs recorded in VR mode are not playable in standard DVD players, but may be playable in other DVD recorders and DVD-ROM drives (in the case of DVD-ROM drives, the disc will need to be finalized first).  
DVD-RW discs recorded in VR mode are playable in some players and other recorders.  
*Note that discs may not play due to recording or disc characteristics, scratches or dirt on the disc or pickup lens, etc.*
- RW COMPATIBLE** This label indicates playback compatibility with DVD-RW discs recorded in VR mode (Video Recording format). However, for discs recorded with a record-only-once encrypted program, playback can only be achieved using a CPRM compatible device.  
*Note that Pioneer cannot guarantee that discs recorded using this recorder will play on other players.*

\* 'DVD-Video format' recording: The use of the DVD-Video format for recording on DVD-R and DVD-RW discs is referred to as recording in 'Video mode' on Pioneer's DVD recorders. Supporting playback of DVD-R / DVD-RW discs is optional for manufacturers of DVD playback equipment, and there is DVD playback equipment that does not play DVD-R or DVD-RW discs recorded in the DVD-Video format.

Note: 'Finalization' is required.

This recorder supports the recording of 'copy-once' broadcast programs using the CPRM copy protection system (see CPRM on page 33) on CPRM-compliant discs in VR mode. CPRM recordings can only be played on players that are specifically compatible with CPRM.

- Do I need two DVD recorders for editing? What kind of editing can I do?

Unlike editing video tape, you only need one DVD recorder to edit discs. With VR mode discs, you can edit by making a 'Play List' of what to play and when to play it. On playback, the recorder plays the disc according to the Play List.

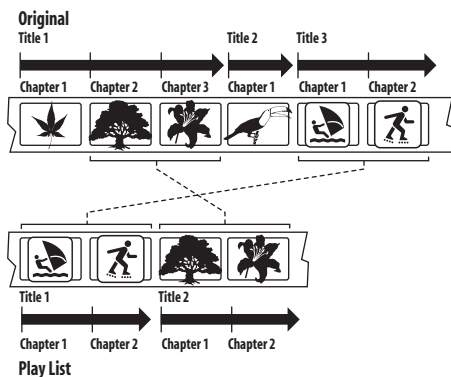

Throughout this manual, you will often see the words Original and Play List to refer to the actual content and the edited version.

- **Original** content refers to what's actually recorded on the disc.
- **Play List** content refers to the edited version of the disc—how the Original content is to be played.

## Chapter 2

## Connecting up

## Rear panel connections

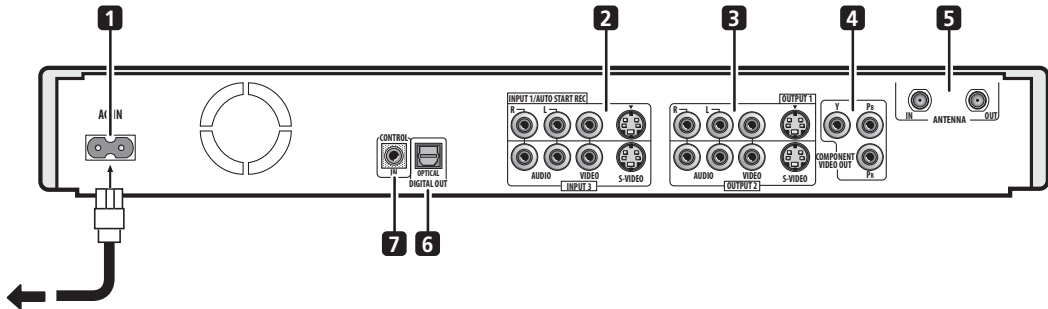
**1 AC IN**

Connect to a power outlet using the supplied power cable after making all other connections.

**2 Audio/video inputs 1 and 3**

Two sets of audio/video inputs (stereo analog audio; composite and S-video video) that you can use to connect to satellite receivers, TVs, VCR or other source component for recording.

**3 Audio/video outputs 1 and 2**

Two sets of audio/video outputs (stereo analog audio; composite and S-video video) that you can use to connect TVs or monitors.

**4 COMPONENT VIDEO OUT**

A high-quality video output for connecting to a TV or monitor with a component video input.

**5 ANTENNA IN (RF IN)/OUT**

Connect your TV antenna to the **ANTENNA IN (RF IN)** jack. The signal is passed through to the **ANTENNA OUT** jack for connection to your TV.

**6 OPTICAL DIGITAL OUT**

A digital audio output for connecting to an AV amp/receiver, Dolby Digital/DTS decoder or other equipment with optical digital input.

**7 CONTROL IN**

Use to control this recorder from the remote sensor of another Pioneer component with a **CONTROL OUT** terminal and bearing the Pioneer  mark. Connect the **CONTROL OUT** of the other component to the **CONTROL IN** of this recorder using a mini-plug cord.

## Front panel connections

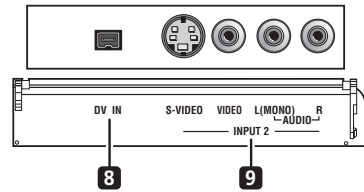

On the right side of the front panel a flip-down cover hides more connections.

**8 DV IN**

A DV input i.LINK connector, suitable for connecting a DV camcorder.

**9 Audio/video input 2**

Audio/video input (stereo analog audio; composite and S-video video), especially suitable for camcorders, game consoles, portable audio, etc.

## Easy connections

The setup described here is a basic configuration that allows you to record TV programs on both this recorder and your VCR. When watching recordings from this recorder, set your TV to input 1; switch to input 2 to watch a video playing in the VCR.

### Important

- This recorder is equipped with copy protection technology. Do not connect this recorder to your TV via a VCR (or your VCR via this recorder) using AV cables, as the picture from this recorder will not appear properly on your TV.
- Before making or changing any rear panel connections, make sure that all components are switched off and unplugged from the wall outlet.

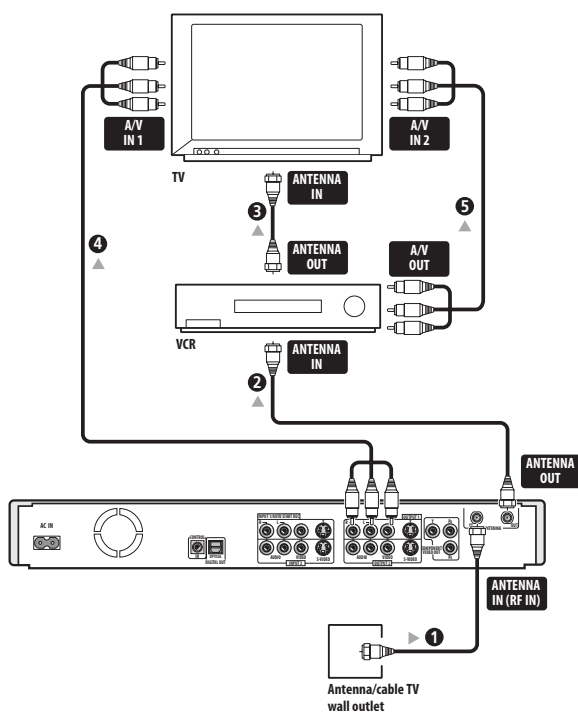

**1** Connect your TV antenna/cable TV outlet to the ANTENNA IN (RF IN) jack on this recorder.

**2** Use an RF antenna cable (one is supplied) to connect the ANTENNA OUT jack on this recorder to the antenna input on your VCR.

- If you are not connecting a VCR in the chain, connect this recorder directly to your TV and skip the next step.

**3** Use an RF antenna cable to connect the antenna output on your VCR to the antenna input on your TV.

**4** Connect the AUDIO and VIDEO OUTPUT jacks (1 or 2) to a set of audio/video inputs on your TV.

Use the supplied three-pin audio/video cable. It is color-coded to help you match them up (red/white for the right/left audio connections and yellow for video in/outs). Make sure you match up the left and right outputs with their corresponding inputs for correct stereo sound.

**5** Connect your VCR to your TV (A/V IN 2 above) using a set of audio and video cables.

- See the following page if you want to use S-video or component video cables for the video connection.

## Using other types of video output

This recorder has standard (composite), S-video and component video outputs. The main difference between them is the quality of the picture. S-video delivers a better picture than composite video, while component video gives better picture quality still. The variety of outputs also gives you the flexibility of connecting your particular equipment using the best connection type available.

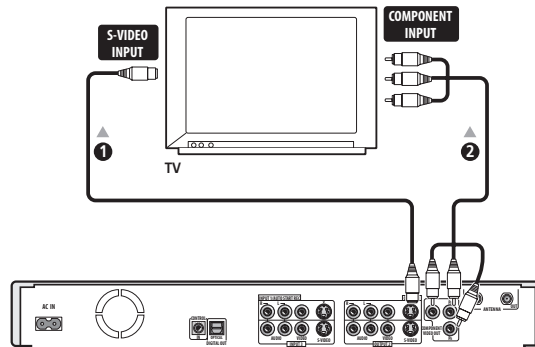

### 1 Connecting using an S-video output

S-video carries the picture as separate color and luminance (brightness) signals.

There are two S-video outputs for connection to TVs, monitors, VCRs or other equipment.

- Use an S-video cable (not supplied) to connect an S-VIDEO OUTPUT (1 or 2) to an S-video input on your TV, monitor (or other equipment).

### 2 Connecting using the component video output

Component video carries the picture as two separate color signals, plus a luminance (brightness) signal.

See also *Component Video Out* on page 69 for how to set up the component video output for use with a progressive scan-compatible TV.

- Use a component video cable (not supplied) to connect the COMPONENT VIDEO OUT jacks to a component video input on your TV, monitor (or other equipment).

## Connecting to a cable box or satellite receiver (1)

If you are using a cable box or satellite receiver with only a few scrambled channels, follow the setup on this page<sup>1</sup>. If many or all the channels are scrambled, we recommend using the setup on the following page.

Using the setup on this page you can:

- Record unscrambled channels by selecting them on this recorder.
- Record scrambled channels by selecting them on the cable box/satellite receiver and using the Auto Start Recording feature (see *Automatic recording from a satellite tuner* on page 42).
- Watch one channel while recording another.

### Important

- Do not connect this recorder 'through' your VCR, satellite receiver or cable box. Always connect each component directly to your TV or AV amp/receiver.

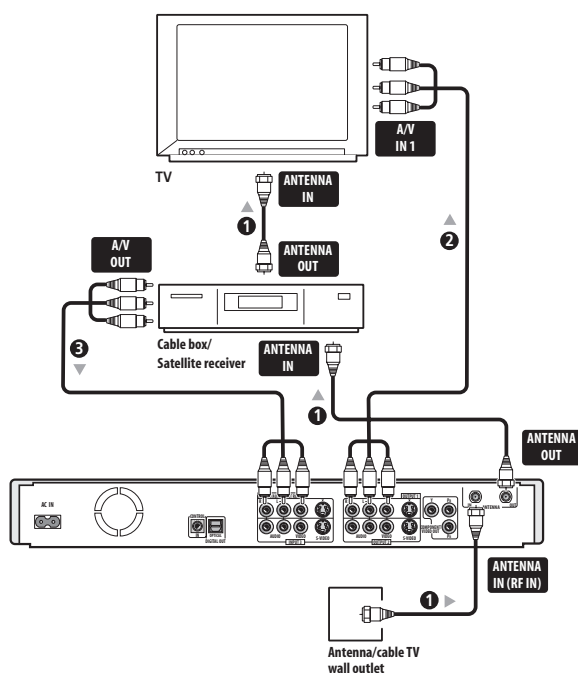

### 1 Connect RF antenna cables as shown.

This enables you to watch and record TV channels.

### 2 Connect the AUDIO and VIDEO OUTPUT jacks (1 or 2) on this recorder to a set of audio/video inputs on your TV using a set of A/V cables (as supplied).

This enables you to watch the output from this recorder.

### 3 Connect the audio/video output of your cable box/satellite receiver to the INPUT jacks on this recorder using a set of A/V cables.

This enables you to record scrambled TV channels.

### Note

1. The diagram shows standard video connections, but you can alternatively use the S-video or component video connections if they're available.

## Connecting to a cable box or satellite receiver (2)

If many or all the channels you receive by cable or satellite are scrambled, we recommend using this setup.<sup>1</sup>

Using the setup on this page you can:

- Record any channel by selecting it on the cable box/satellite receiver.
- Record using the Auto Start Recording feature (see *Automatic recording from a satellite tuner* on page 42).

### Important

- Do not connect this recorder 'through' your VCR, satellite receiver or cable box. Always connect each component directly to your TV or AV amp/receiver.

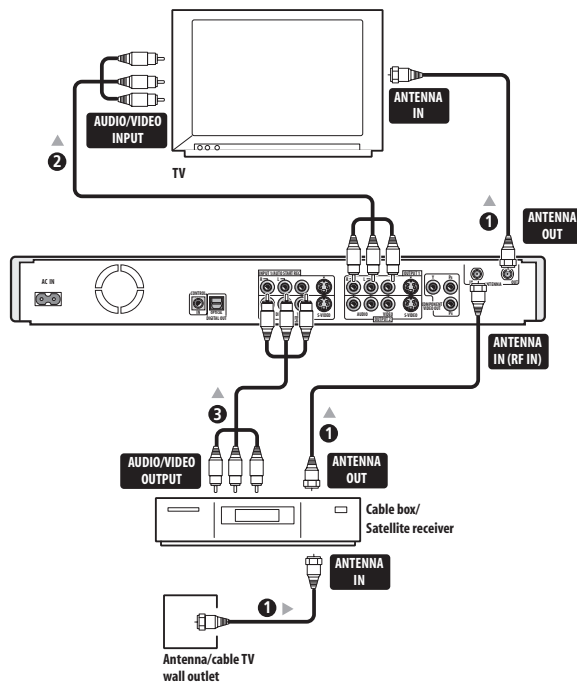

### 1 Connect RF antenna cables as shown.

This enables you to watch and record TV channels.

### 2 Connect the AUDIO and VIDEO OUTPUT jacks (1 or 2) on this recorder to a set of audio/video inputs on your TV using a set of A/V cables (as supplied).

This enables you to watch discs.

### 3 Connect the audio/video output of your cable box/satellite receiver to the INPUT jacks on this recorder using a set of A/V cables.

This enables you to record scrambled TV channels.

### Note

- The setup on this page does not allow you to watch one channel and record another.
  - The diagram shows standard video connections, but you can alternatively use the S-video or component video connections if they're available.



## Connecting to an AV amplifier or receiver

To enjoy multichannel surround sound you need to connect this recorder to an AV amp/receiver using the digital optical output. In addition to the digital connection, we recommend also connecting using the stereo analog connection.

You'll probably also want to connect a video output to your AV amp/receiver. Use the standard (composite) video output (as shown here), or the S-video or component video connections.

See also *Audio Out Settings* on page 70 for how to set up the digital audio output. (Noise may be output from your speakers if the recorder is not set up to work with your AV amp/receiver.)

### Important

- Do not connect this recorder to your TV 'through' your VCR or other component using A/V cables. Always connect it directly to your TV.

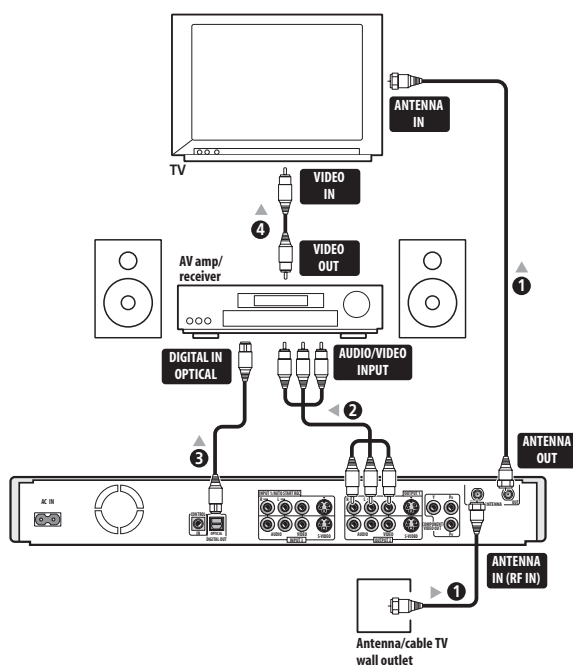

#### 1 Connect RF antenna cables as shown.

This enables you to watch and record TV channels.

#### 2 Connect the AUDIO and VIDEO OUTPUT jacks (1 or 2) on this recorder to a set of audio/video inputs on your AV amp/receiver.

#### 3 Use an optical digital audio cable (not supplied) to connect the OPTICAL DIGITAL OUT jack on this recorder to an optical digital input on your AV amp/receiver.

This enables you to listen to multichannel surround sound.<sup>1</sup>

#### 4 Connect the AV amp/receiver's video output to a video input on your TV.

### Note

1. If your AV amp/receiver doesn't have an optical digital input, but has a coaxial type, converter boxes that convert from optical to coaxial are available at specialist audio dealers.

## Connecting other AV sources

### Connecting a VCR or analog camcorder

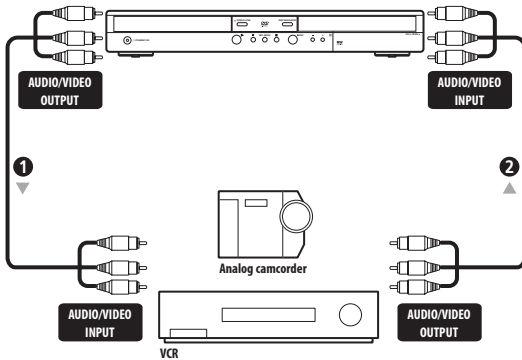

**1 Connect a set of audio and video inputs of your VCR or camcorder to a set of outputs on this recorder.**

This enables you to record from this recorder to your VCR or camcorder.

- You can use standard video or S-video cables for the video connection.

**2 Connect a set of audio and video outputs of your VCR or camcorder to a set of inputs on this recorder.**

This enables you to record tapes from your VCR or camcorder.

- You can use standard video or S-video cables for the video connection.
- The front panel connections make convenient connections for a camcorder input.

### Connecting a DV camcorder

Using the front panel **DV IN** jack, it is possible to connect a DV camcorder or video deck, or DVD-R/RW recorder and digitally transfer DV tapes or DVD-R/RW discs to DVD-R/RW.

#### Important

- This jack is for connection to DV equipment only. It is not compatible with digital satellite receivers or D-VHS video decks.

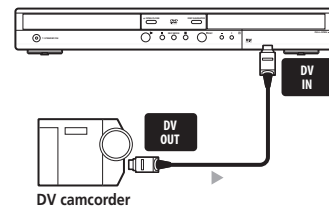

**1 Use a DV cable (not supplied) to connect the DV jack of your DV camcorder/video deck to the front panel DV IN jack of this recorder.**

## Plugging in

After checking all the connections, plug in the recorder.

**1 Use the supplied power cable to connect this recorder to a power outlet.**

## Chapter 3

# Controls and displays

### Front panel

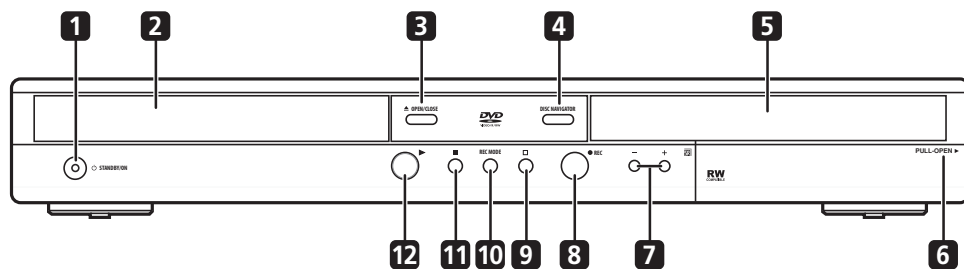

#### 1 STANDBY/ON

Press to switch the recorder on/into standby.

#### 2 **Disc tray**

#### 3 OPEN/CLOSE

Press to open/close the disc tray.

#### 4 **DISC NAVIGATOR** (page 47, 54)

Press to directly access the Disc Navigator screen.

#### 5 **Front panel display and IR remote sensor**

See *Display* on page 22 for details.

#### 6 **Front panel inputs** (page 12)

Pull the cover down where indicated to access the front panel input jacks (audio, video and DV). Especially convenient for connecting camcorders and other portable equipment.

#### 7 **+/-**

Use to change channels, skip chapters/tracks, etc.

#### 8 **REC**

Press to start recording. Press repeatedly to set the recording time in 30 minute blocks.

#### 9

Press to stop recording.

#### 10 **REC MODE** (page 33)

Press repeatedly to change the recording mode (picture quality).

#### 11

Press to stop playback.

#### 12

Press to start or restart playback.

## Remote control

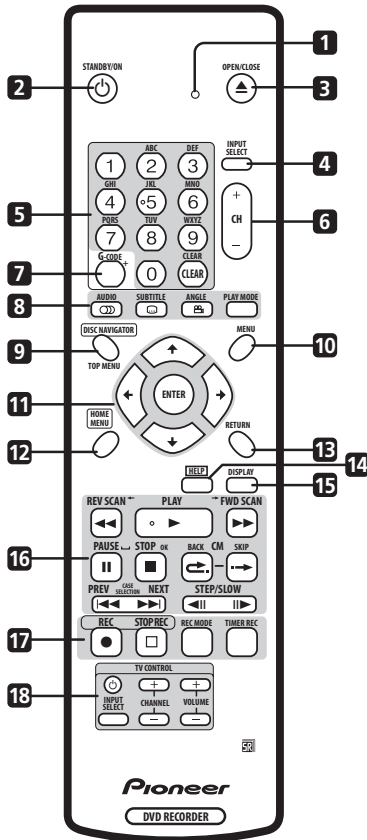

### 1 Remote control indicator

Lights when setting up the remote control for use with a TV (page 75) and when setting the remote control mode (page 73).

### 2 **⏻** STANDBY/ON

Press to switch the recorder on/into standby.

### 3 **⏏** OPEN/CLOSE

Press to open/close the disc tray.

### 4 **INPUT SELECT** (page 41)

Press to change the input to use for recording.

### 5 **Alphanumeric buttons, + and CLEAR**

Use the number buttons for track/chapter/title selection; channel selection, and so on. The same buttons can also be used to enter names for titles, discs and so on.

Use the + button to enter non-alphanumeric characters and symbols.

Use **CLEAR** to clear an entry and start again.

### 6 **CH +/-** (page 26)

Press to change the channel of the built-in TV tuner.

### 7 **G-Code** (page 36)

Press then use the number buttons to enter a G-Code programming number for timer recording.

### 8 **DVD playback functions**

#### **AUDIO** (page 26, 52, 53)

Changes the audio language or channel. (When the recorder is stopped, press to change the tuner audio.)

#### **SUBTITLE** (page 52)

Displays/changes the subtitles included in multilingual DVD-Video discs.

#### **ANGLE** (page 53)

Switches camera angles on discs with multi-angle scenes.

#### **PLAY MODE** (page 49)

Press to display the Play Mode menu (for features such as search, repeat and program play).

### 9 **DISC NAVIGATOR** (page 47, 54) / **TOP MENU**

(page 28)

Press to display the Disc Navigator screen, or the top menu if a DVD-Video disc is loaded.

### 10 **MENU** (page 28)

Press to display the disc menu if a DVD-Video disc is loaded.

### 11 **↑/↓/←/→ and ENTER**

Used to navigate all on-screen displays. Press **ENTER** to select the currently highlighted option.

### 12 **HOME MENU** (page 29)

Press to display the Home Menu, from which you can navigate all the functions of the recorder.

### 13 **RETURN**

Press to go back one level in the on-screen menu or display.

## 14 HELP

Press for help on how to use the current GUI screen.

## 15 DISPLAY (page 30)

Displays/changes the on-screen information displays.

## 16 Playback controls (page 27)

### ◀◀ REV SCAN / FWD SCAN ▶▶ (page 48)

Press to start reverse or forward scanning. Press again to change the speed.

### ▶ PLAY

Press to start playback.

### ⏸ PAUSE

Press to pause playback or recording.

### ■ STOP

Press to stop playback.

### CM BACK (commercial back)

Press repeatedly to skip progressively backward through the audio or video playing.

### CM SKIP (commercial skip)

Press repeatedly to skip progressively forward through the audio or video playing.

### ⏮ PREV / NEXT ⏭

Press to skip to the previous or next title/chapter/track/folder; or to display the previous or next menu page.

### ◀◀ STEP/SLOW ▶▶ (page 49)

During playback, press to start slow-motion playback; while paused, press to show the previous or next video frame.

## 17 Recording controls (page 25)

### ● REC

Press to start recording. Press repeatedly to set the recording time in blocks of 30 mins.

### □ STOP REC

Press to stop recording.

### REC MODE (page 33)

Press repeatedly to change the recording mode (picture quality).

### TIMER REC (page 34)

Press to start setting a timer recording.

## 18 TV CONTROL (page 75)

After setting up, use these controls to control your TV.

## Display

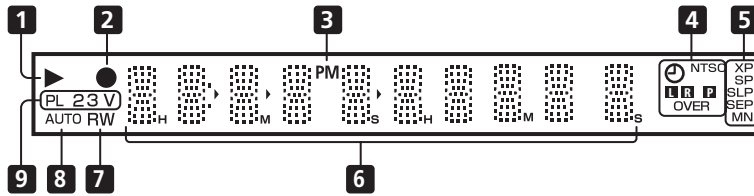

### 1 ►

Lights during playback; blinks when playback is paused.

### 2 ●

Lights during recording; blinks when recording is paused.

### 3 PM

Lights to indicate PM (after midday) for the clock display.

### 4 ⌚ (page 34)

Lights when a timer recording has been set. (Indicator blinks if the timer has been set but there isn't a recordable disc loaded.)

### NTSC

Lights when playing NTSC format video.

### LR (page 70)

Indicates which channels of a bilingual broadcast are recorded.

### PR (page 69)

Lights when the component video output is set to progressive scan.

### OVER (page 70)

Lights when the analog audio input level is too high.

### 5 Recording quality indicators (page 32)

#### XP

Lights when the recording mode is set to **XP** (best quality).

#### SP

Lights when the recording mode is set to **SP** (standard play).

#### LP / SLP

Lights when the recording mode is set to **LP** (long play) or **SLP** (super long play).

#### EP / SEP

Lights when the recording mode is set to **EP** (extended play) or **SEP** (super extended play).

#### MN

Lights when the recording mode is set to **MN** (manual recording level) mode.

### 6 Character display

#### 7 R / RW

Indicates the type of recordable DVD loaded: DVD-R or DVD-RW.

#### 8 AUTO

Lights when Auto Start Recording has been set, and during Auto Start Recording.

#### 9 PL (page 54)

Lights when a VR mode disc is loaded and the recorder is in Play List mode.

#### 2 3 (page 73)

Shows the remote control mode (if nothing is displayed, the remote control mode is 1).

#### V

Lights when an unfinalized Video mode disc is loaded.

## Chapter 4

# Getting started

### Switching on and setting up

When you switch the recorder on for the first time, you can make several basic settings using the Setup Navigator feature. This takes you through setting the clock, the internal TV tuner and the video output settings.

If you're using the recorder for the first time, we strongly recommend you use the Setup Navigator before starting to use the recorder.

#### Important

- Some of the Setup Navigator on-screen displays (OSDs) in this section vary slightly depending on the country or region of purchase.

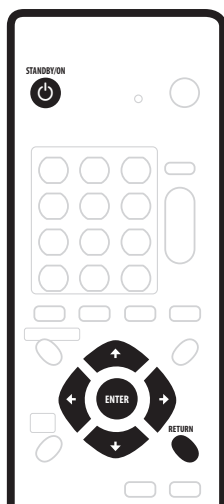

**1 Switch on your TV and set the video input to this recorder.**

**2 Press the  STANDBY/ON button on the remote control or the front panel to switch on.**

When you switch on for the first time, your TV should display the Setup Navigator screen. (If the Setup Navigator doesn't appear, you can also access it from the Initial Setup menu; see page 68).

**3 Use the  $\uparrow/\downarrow$  buttons to choose a language, then press ENTER.**

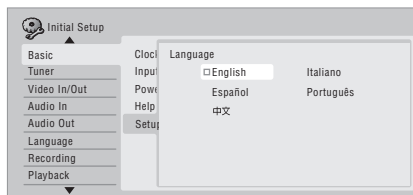

**4 Press ENTER to start setting up using the Setup Navigator.**

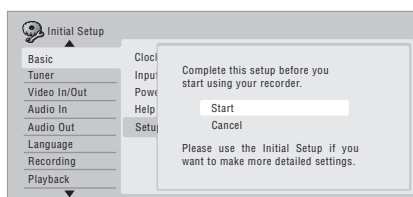

- If you don't want to use the Setup Navigator, press  $\downarrow$  to select **Cancel**, then press **ENTER** to exit the Setup Navigator.

**5 Select 'Auto Scan' then press ENTER.**

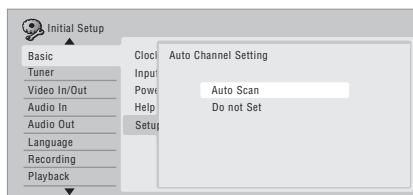

- Select **Do not set** if you want to skip setting up the channels (because they have already been set up, for example).
- Use the  $\leftarrow/\rightarrow$  buttons to choose your country, then press **ENTER**.

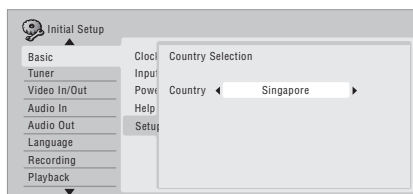

- **Auto-tuning channels**

The **Auto Scan** option automatically scans and sets the channel presets.

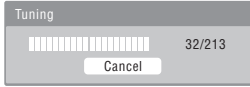

**6 Select 'Auto' for automatic time setting, or 'Manual' to set the clock manually, then press ENTER.**

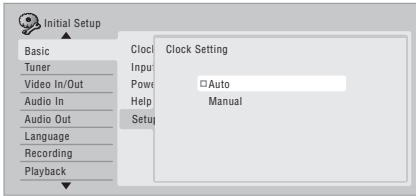

- **Auto clock setting**

Some TV channels broadcast time signals together with the program. This recorder can use these signals to set the clock automatically.

**Set 'Clock Set CH' to the channel preset number that broadcasts a time signal, then move the cursor down to 'Start' and press ENTER.**

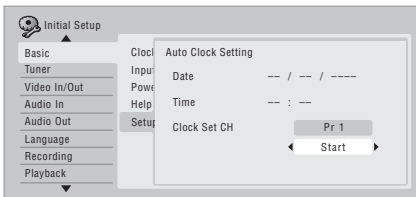

The recorder takes a short while to set the time. After you see that the time has been set, select **Next** to proceed.

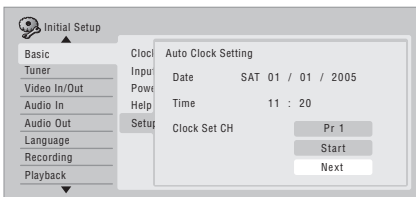

If the time could not be set automatically, press **RETURN** to go back to the previous screen and select **Manual**.

- **Manual clock setting**

If no stations in your area are broadcasting time signals, you can set the clock manually.

**Use the ←/→ buttons to set your time zone.**

You can set this by selecting a city or a time relative to GMT.

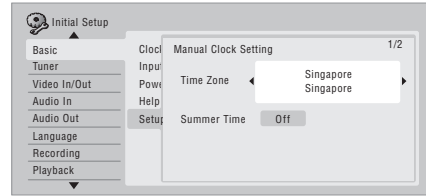

**Press ↓ then use the ←/→ buttons to select 'On' or 'Off' for summer time, then press ENTER.**

Select **On** if you are currently using summer time.

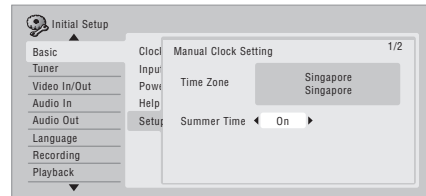

**Set the date (day/month/year) and time, then press ENTER to make all the settings.**

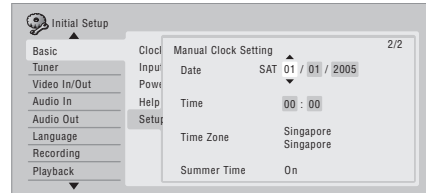

Use the ↑/↓ buttons to change the value in the highlighted field.

Use the ←/→ buttons to move from one field to another.

- You can go back to the previous screen at anytime in the Setup Navigator by pressing **RETURN**.



## 7 Select the TV screen type, 'Wide (16:9)' or 'Standard (4:3)'.

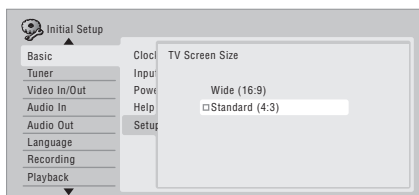

Use the **↑/↓** buttons to select, then press **ENTER**.

## 8 Is your TV compatible with progressive scan video?

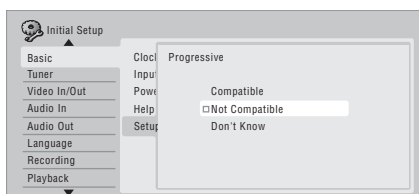

Use the **↑/↓** buttons to select **Compatible**, **Not Compatible**, or **Don't Know**, then press **ENTER**.

- Note that progressive scan video is only output through the component video outputs and only when the video source is NTSC (see *Using other types of video output* on page 14).

## 9 Press ENTER to exit the Setup Navigator, or select 'Go Back' if you want to start again.

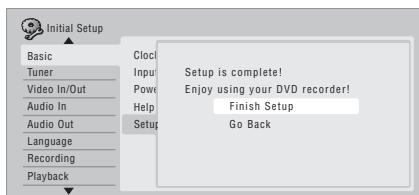

That completes basic setup using the Setup Navigator.

## Other settings you can make

After setting up using the Setup Navigator, you should be ready to start enjoying your DVD recorder. It's possible, however, that you may want to make a couple of additional settings, depending on how the recorder is set up for TV broadcasts.

- Manual channel setting – This setting lets you skip channels where there is no station, as well as manually tune to stations. See *Manual CH Setting* on page 69.
- G-Code channel setting - This setting lets you assign guide channels to ensure that the G-Code programming system works correctly. See *G-Code CH Setting* on page 69.
- Setting up the remote to control your TV – You can set up the supplied remote control to control many brands of TV. See *Setting up the remote to control your TV* on page 75.

## Making your first recording

This quick guide shows you how to make a basic recording of a TV program to a recordable DVD.

Recording is covered in much more detail in chapter 5 (*Recording*).

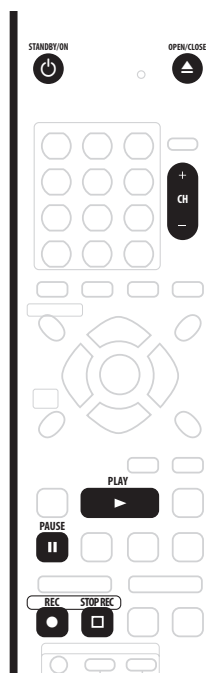

### 1 If they aren't already on, switch on your TV and this recorder.

Press **STANDBY/ON** to switch on.

- Make sure that the video input on your TV is set to this recorder.

### 2 Press **▲ OPEN/CLOSE** to open the disc tray.

### 3 Load a blank DVD-R or DVD-RW disc with the label side face-up, using the disc guide to align the disc.

- When you load a new, blank DVD-RW disc, the recorder will take a moment to initialize it for recording.
- Blank DVD-R discs are ready for Video mode recording out of the box.

### 4 Use the **CH +/-** buttons to select the TV channel you want to record from.

- You can also use the **+/-** buttons on the front panel if the recorder is stopped.
- Channel presets are numbered 1–99.

### 5 Press **● REC** to start recording.

- By default, the recording will be in **SP** (standard play) mode, which will give you around two hours of recording from a blank DVD disc.
- You can pause recording by pressing **|| PAUSE**. Press **● REC** or **|| PAUSE** again to restart recording.

### 6 When you want to stop recording, press

**□ STOP REC.**

## Playing back your recording

The TV program you just recorded should be on the DVD disc as a single title with one or more chapters.

### • Press **▶ PLAY** to start playback.

If you want to stop playback before the end of the recording, press **■ STOP**.

## Using the built-in TV tuner

### Changing TV channels

There are three different ways to select TV channels. Note that you can't change the TV channel during playback, recording or during recording standby.

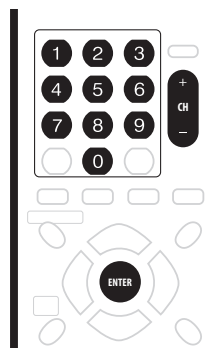

- **CH +/-** buttons on the remote
- **Number buttons** on the remote – For example, to select channel 4, press **4** then **ENTER**; for channel 34, press **3**, **4**, **ENTER**.<sup>1</sup>
- **+/-** buttons on the front panel

### Changing audio channels

You can change the audio channel of the broadcast or external input signal.

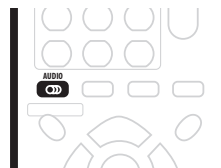

- Press **AUDIO** to change the audio.

The current audio channel is displayed on-screen.

- If the NICAM audio setting (see *Nicam Select* on page 69) is set to **NICAM** and you are watching a NICAM broadcast, you can switch between **NICAM** and **Regular** (non-NICAM) audio.



#### Note

1. Channel presets are numbered 1–99.

- If the NICAM broadcast is bilingual, you can also select the language.



- You can also select the language for a non-NICAM bilingual broadcast.

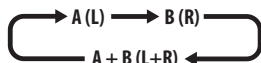

- When watching a recording made from an external input with **Bilingual** recording selected (see *External Audio* on page 70), you can switch the audio channel between left (L), right (R) or both (L+R).



### Tip

- When recording in Video mode, or on the **LPCM** setting, only one channel of a bilingual broadcast is recorded. In this case, decide which language you want to record before recording by setting the Bilingual Recording setting (see *Bilingual Recording* on page 70).

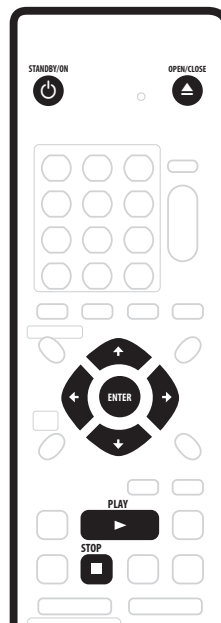

#### 1 Press **⏻** STANDBY/ON to switch on.

Also turn on your TV and make sure that it is set to the correct video input.

#### 2 Press **⏮** OPEN/CLOSE to open the disc tray.

#### 3 Load a disc.

Load a disc with the label side facing up, using the disc tray guide to align the disc (if you're loading a double-sided DVD-Video disc, load it with the side you want to play face down).

- If you want to play a DTS audio CD, please first read the note on page 28.

#### 4 Press **▶** PLAY to start playback.

- If you're playing a DVD-Video or Video CD, a disc menu may appear when you start playback. Use the **↑/↓/←/→** buttons and **ENTER** to navigate DVD disc menus, and the number buttons and **ENTER** for Video CD menus.
- See the following sections for more details on playing specific kinds of discs.

#### 5 To stop playback, press **■** STOP.

#### 6 When you've finished using the recorder, eject the disc and switch the recorder back into standby.

- To open/close the disc tray, press **⏮** OPEN/CLOSE. Remove the disc before putting the recorder into standby.
- Press **⏻** STANDBY/ON to switch the recorder into standby.

## Basic playback

This section shows you how to use your recorder for playback of discs (DVD, CD, etc.). More playback features, such as repeat and program play, are covered in *Playback* on page 46.







### Important

- Throughout this manual, the term 'DVD' means playback-only DVD-Video discs and DVD-R/RW. If a function is specific to a particular kind of DVD disc, it is specified.
- Some DVD-Video discs don't allow certain playback controls to operate at certain points in the disc. This is not a malfunction.



## Playing DVD discs



The table below shows the basic playback controls for DVD-Video, and recordable DVD discs.

 Press to start playback.  
If **RESUME** is displayed on-screen, playback starts from the place last stopped.

 Press to stop playback.  
You can resume playback from the same point by pressing  **PLAY**. (Press  **STOP** again to cancel the resume function.)

 Pauses playback, or restarts playback when paused.

  Press to start scanning. Press repeatedly to increase the scanning speed.

  Press to skip to previous/next chapter/title. (During playback you can also use the front panel **+/-** buttons.)

 *Except VR mode:* During playback, enter a chapter number then press **ENTER** to skip directly to that chapter within the currently playing title.



On some discs, you can also use the number buttons to select numbered items in the disc menu.

 *VR mode only:* During playback, enter a title number then press **ENTER**.

*All:* Press **CLEAR** to clear a number entry and start again.

 (Commercial back/skip) Each press skips backward/forward progressively up to a maximum of ten minutes forward or three minutes back.

 During playback, press to start slow-motion playback. Press repeatedly to change the playback speed.  
While paused, press to advance a single frame in either direction.

  Press to display the menu of a DVD-Video disc.

 Use the cursor buttons to navigate DVD-Video disc menus; press **ENTER** to select items.

 Press to return to the previous level of a DVD-Video disc menu.



## Playing CDs and WMA/MP3 discs



The table below shows the basic playback controls for audio CDs<sup>1</sup>, and WMA/MP3 files.

 Press to start playback.

 Press to stop playback.

 Pauses playback, or restarts playback when paused.

  Press to start scanning. Press again to increase the scanning speed. (There are two scan speeds; the current scan speed is shown on-screen.)

  Press to skip to previous/next track (or folder for WMA/MP3 disc). (During playback you can also use the front panel **+/-** buttons.)

 During playback, enter a track number then press **ENTER** to skip directly to that track.

Press **CLEAR** to clear a number entry and start again.













### Note

1. If you want to play a DTS audio CD, make sure the recorder is connected to a DTS-compatible amp/receiver with a digital connection. Noise will be output through the analog outputs. Also make sure that **STEREO** is selected using the **AUDIO** button (see *Switching audio channels* on page 53).

## Playing Video CD/Super VCDs

The table below shows the basic playback controls for Video CD/Super VCDs.

Some discs feature Playback Control (PBC for short) menus. These discs show PBC in the display when you load them and display a menu on-screen from where you can select what to watch.<sup>1</sup>

	Press to start playback. <i>Video CD only:</i> If <b>RESUME</b> is displayed on-screen, playback starts from the place last stopped.
	Press to stop playback. <i>Video CD only:</i> You can resume playback from the same point by pressing ► <b>PLAY</b> . (Press ■ <b>STOP</b> again to cancel the resume function.)
	Pauses playback, or restarts playback when paused.
	Press to start scanning. Press repeatedly to increase the scanning speed.
	Press to skip to previous/next track. When a PBC menu is displayed, press to display the previous/next page. (During playback you can also use the front panel +/- buttons.)
	During playback, enter a track number then press <b>ENTER</b> to skip directly to that track. Press <b>CLEAR</b> to clear a number entry and start again.
	While a PBC menu screen is displayed, use to select numbered menu items.
	<i>Video CD only:</i> Each press skips backward/forward progressively up to a maximum of ten minutes forward or three minutes back. Note that this function doesn't work when playing in PBC mode.
	During playback, press to start slow-motion playback. Press repeatedly to change the playback speed (forward only). While paused, press to advance a single frame (forward only).
	Press to display the disc menu of a Video CD/Super VCD playing in PBC mode.

## Using the Home Menu

From the Home Menu screen you can access all the features of the recorder.

Note that some options in the Home Menu may be grayed out sometimes, indicating that they are not available at the present time. For example, the Photo Viewer option is grayed out unless there is a disc loaded that contains JPEG image files.

Press **HOME MENU** to display the Home Menu screen:



Use the ↑/↓/←/→ buttons followed by **ENTER** to select the option you want. To exit the Home Menu, press **HOME MENU**.

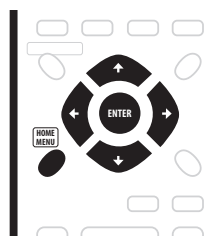

### Home menu options

<b>Disc Navigator</b> (page 47, page 54)	<b>Disc Setup</b> (page 63) page 54)
<b>Timer Recording</b> (page 34)	<b>Initial Setup</b> (page 68)
<b>Play Mode</b> (page 49)	<b>Video/Audio Adjust</b> (page 65)
<b>DV Record</b> (page 42)	<b>Photo Viewer</b> (page 61)

### Note

1. When playing in PBC mode, some playback features, such as search, repeat and program play are not available. You can play a PBC Video CD/Super VCD in non-PBC mode by pressing ►► to start playback instead of ► **PLAY**.

## Displaying disc information on-screen

You can display various on-screen information about the disc loaded.

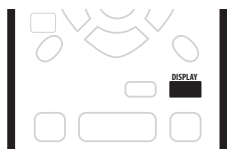

### 1 Press DISPLAY repeatedly to display/change the on-screen information.

- The on-screen display automatically disappears after 150 minutes.

### 2 To hide the information display, press DISPLAY repeatedly until it disappears.

The example displays below are a guide only; actual displays vary according to the disc loaded, etc.

#### Stop display 1

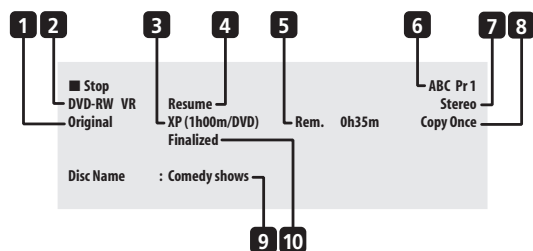

#### 1 DVD-RW Original / Play List

If a VR mode disc is loaded, this shows whether playback is currently set to **Original** or **Play List**.

#### 2 Disc type and mode

Shows the disc type (**HDD**, **DVD-R**, **DVD-RW**, **CD**, etc.), and the disc mode for recordable DVD, if applicable (**VR** or **Video**).

#### 3 Recording mode and time

Shows the current recording mode (**XP**, **SP**, **LP**, etc.), and the total recording time of the disc.

#### 4 Resume

Shows **Resume** if playback can be resumed from the last place stopped.

#### 5 Recording time remaining

Shows the approximate recording time left on the disc in the current recording mode.

#### 6 Preset name and number

Shows the preset name and preset number for the currently selected channels.

#### 7 Audio mode

Shows the broadcast audio mode for the current channel preset (**Mono**, **Stereo**, etc.).

#### 8 Copy control information

Shows recording restrictions of the current channel program.

#### 9 Disc name

Shows the disc name.

(For CDs, this area shows playable files other than CD audio tracks; for example, **Multi-format: WMA/MP3**.)

#### 10 Finalized

Shows **Finalized** if a recordable DVD is finalized.

#### Stop display 2

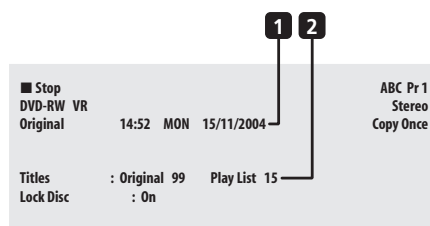

#### 1 Date and time

#### 2 Number of titles/tracks on disc

For a VR mode DVD-RW, the number of Original and Play List titles are shown separately.

#### Play display 1

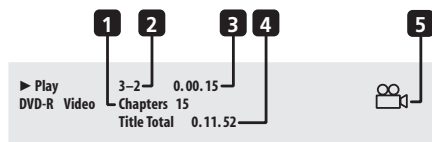

#### 1 Number of chapters in title

#### 2 Current title and chapter number

(For CD/Video CD/Super VCD, shows current track; for WMA/MP3, shows current folder and track; for JPEG disc, shows current folder and file.)

#### 3 Elapsed title time

(For CD, WMA, MP3, Super VCD, shows elapsed track time; for Video CD, shows elapsed disc time.)

#### 4 Total running time of title

#### 5 Angle indicator

Lights during multi-angle scenes.

## Play display 2

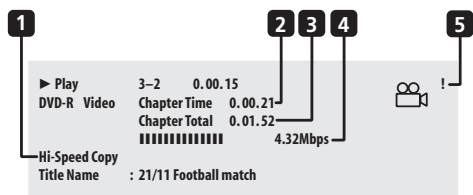

### 1 Chase playback, simultaneous record/playback, copy, disc back-up

Indicates that recording, copying or back-up is in progress.

### 2 Elapsed chapter time

### 3 Total running time of chapter

### 4 Data transfer rate

Shows the current data rate being read from the disc.<sup>1</sup>

### 5 Copy protected material (!) / PureCinema indicator (#)

Shows '!' if the playback material is copy-once protected.

Shows '#' if the current video is 24 fps, progressive scan.



### Tip

- When using the simultaneous play and record feature, the display shows information for playback only.
- The Video mode disc displays become the same as a DVD-Video disc once the disc is finalized.
- The total recording time figure shown in parenthesis is calculated based on a 12cm/4.7GB disc at the displayed record setting.
- Recording and playback times for TV recordings are approximately 0.1% shorter than the actual time. This is because of the slightly different frame rates of TV broadcasts versus DVD.
- The frame number is shown next to the elapsed time display when the disc is paused.
- **Copy Once** or **Can't Record** messages may appear in the stop or recording displays. These indicate that the broadcast TV program contains copy control information.

## Recording display

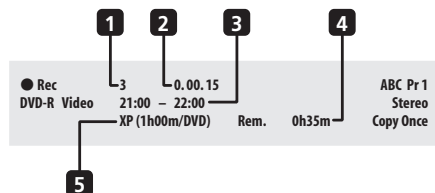

### 1 Current title number

### 2 Elapsed recording time

### 3 Timer recording start and stop times

Shows the start and stop times if the current recording is a timer recording.

### 4 Remaining recording time available

Shows the amount of space left on the disc in the current recording mode.

### 5 Recording mode

Shows the current recording mode (**XP**, **SP**, **LP**, etc.), and the total recording time of the disc.

### Note

1. Data transfer rate shows the amount of video and audio information recorded on the disc. It is not an indication of picture/audio quality.

## Chapter 5

# Recording

### About DVD recording

This recorder can record on both DVD-R and DVD-RW media. The main difference between the two is that DVD-R discs can only be recorded once, while DVD-RW can be recorded, erased and re-recorded many times.

Both types of disc can be initialized for *Video mode* or *VR mode* recording. Each has its advantages, and it depends on what you want to do with the recording which mode you choose.

If you want to edit your recordings in any significant way, VR mode is the one to go for as it offers greater possibilities for cutting, copying, and changing the way the video is presented.

Video mode is less flexible when it comes to editing, but it has the advantage that it is compatible with standard DVD players (many of which won't play VR mode discs<sup>1</sup>).

Once a disc is initialized for a particular mode, all recording on that disc will be in that mode.



#### Important

- The maximum number of titles and chapters that can be recorded on a VR mode disc is 99 and 999 respectively; on a Video mode disc the maximum number of titles and chapters is 99 and 99. No more recording is possible on a disc that already contains the maximum number of chapters/titles.
- Unfinalized Video mode discs are not usable in other DVD recorders. Likewise, unfinalized video mode discs recorded using other recorders are not usable in this recorder.
- Pioneer takes no responsibility for recording failure due to power cuts, defective discs, or damage to the recorder.
- Fingerprints and small scratches on a disc can affect playback and/or recording performance. Please take proper care of your discs.
- See also *Disc / content format playback compatibility* on page 9 for detailed disc compatibility information.

- Although this recorder can record PAL, SECAM, NTSC and PAL-60, you can't mix multiple TV line systems on one disc. A disc can contain PAL and SECAM recordings, or NTSC and PAL-60. See also *Additional information about the TV system settings* on page 74.

### Recording time and picture quality

There are six preset recording quality modes<sup>2</sup>:

- **XP** – Highest quality setting, gives about one hour of recording time.
- **SP** (Standard Play) – Default quality, sufficient for most applications, gives about two hours of recording time.
- **LP** (Long Play) – Slightly lower video quality, but doubles the recording time to around four hours.
- **EP** (Extended Play) – EP gives you around six hours of recording time.
- **SLP** (Super Long Play) – SLP gives you around eight hours of recording time.
- **SEP** (Super Extended Play) – SEP gives you around ten hours of recording time.

Please note that there is a trade-off between recording time and quality. The longer the possible recording time, the lower the recorded picture quality.

In addition to these settings, when Manual Recording is On (see *Manual Recording* on page 72) you can access 32 different recording quality/time settings (**MN1–MN32**), and a high-quality audio mode (**LPCM**).

When setting a timer recording there is a further option, **AUTO**, which maximizes the recording quality for the space available on the disc loaded at the time of recording.

#### Note

1. Some DVD players, such as some Pioneer models, are compatible with VR mode discs. Check the operating instructions for your player for VR mode compatibility information.
2. All recording times (both in this manual and those shown by the recorder) are approximate. This is because of the way that the video is recorded; you may get slightly more or slightly less, depending on what you're recording.



## Recorded audio

In all except the **LPCM** mode, sound is recorded in two channel Dolby Digital format. When set to **LPCM**, sound is recorded in high quality, uncompressed Linear PCM format.

If the broadcast audio is bilingual and you are recording in Video mode or on the **LPCM** setting, use the Bilingual Recording setting (page 70) to select the **A/L** or **B/R** audio channel to record before recording starts. In other cases, both channels of a bilingual broadcast will be recorded and you can switch on playback.

## Restrictions on video recording

You cannot record copy-protected video using this recorder. Copy-protected video includes DVD-Video discs and some satellite broadcasts. If copy-protected material is encountered during a recording, recording will pause automatically and an error message will be displayed on-screen.

Video that is 'copy-once only' can only be recorded on a disc in VR mode (see below).

When recording a TV broadcast or through an external input, you can display copy control information on screen. (see *Displaying disc information on-screen* on page 30).

## CPRM

CPRM is a copy protection/scrambling system developed for the recording of 'copy once' broadcast programs. CPRM stands for *Content Protection for Recordable Media*.

This recorder is CPRM compatible, which means that you can record copy-once broadcast programs, but you cannot then make a copy of those recordings. CPRM recordings can only be made on CPRM-compatible DVD-R (ver. 2.0/8x or higher) or DVD-RW (ver. 1.1 or higher) discs formatted in VR mode.

DVD CPRM recordings can only be played on players that are specifically compatible with CPRM.

## Recording equipment and copyright

Recording equipment should be used only for lawful copying and you are advised to check carefully what is lawful copying in the country in which you are making a copy. Copying of copyright material such as films or music is unlawful unless permitted by a legal exception or consented to by the rightowners.

- This product incorporates copyright protection technology that is protected by method claims of certain U.S. patents and other intellectual property rights owned by Macrovision Corporation and other rights owners. Use of this copyright protection technology must be authorized by Macrovision Corporation, and is intended for home and other limited viewing uses only unless otherwise authorized by Macrovision Corporation. Reverse engineering or disassembly is prohibited.

## Setting the picture quality/recording time

VR mode Video mode

Before starting a recording, you will usually want to set the picture quality/recording time. There are six standard settings available, which allow you to choose a balance between picture quality and recording time.

When Manual Recording is set to On (see *Manual Recording* on page 72), a further option will be available (**MN1-32** or **LPCM**, depending on what you set).

See also *Recording time and picture quality* on page 32 for more information.

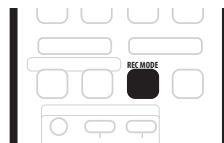

- Press **REC MODE** repeatedly to select a recording setting.

- XP** – High quality
- SP** – Standard play
- LP** – Long play
- EP** – Extended play
- SLP** – Super Long play
- SEP** – Super Extended play
- MN / LPCM**<sup>1</sup> – Manual / Linear PCM (available only when manual recording is on)

The setting is indicated in the front panel display, and shown on-screen together with the recording time for a blank recordable disc. If a recordable disc is loaded, the approximate remaining recording time for that disc is also shown. (Note that if the On Screen Display setting (see *On-Screen Display* on page 73) is **Off** then this information is not displayed.)

### Note

1. Audio is recorded in 16-bit Linear PCM format, video is recorded at XP quality. When recording a bilingual broadcast, select which audio channel to record (see *Bilingual Recording* on page 70).

## Basic recording from the TV

**VR mode** **Video mode**

Follow the instructions below to record a TV program. Recording starts immediately and continues until the disc is full or you stop the recording.

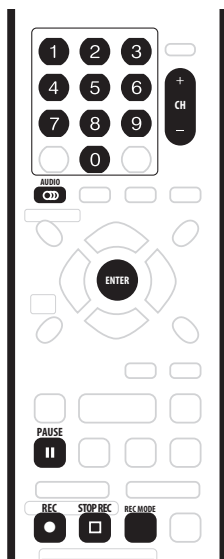

### 1 Load a Recordable disc.

- if you load a new blank DVD-RW disc, the recorder takes a short while to initialize the disc.

### 2 Use the CH +/- buttons to select the TV channel to record.

The front panel display shows the channel number:



- While the recorder is stopped, you can also use the number buttons on the remote to select the channel. (For channel 6, press **6** then **ENTER**; for channel 24, press **2, 4** then **ENTER**)
- If the recorder is stopped, you can also use the **+/-** buttons on the front panel to select the channel number.

### 3 Use the REC MODE button to set the picture quality/recording time.

- See *Setting the picture quality/recording time* on page 33 for detailed instructions.

### 4 Use the AUDIO button to select the audio channel to record.

See *Changing audio channels* on page 26 for more on this.

- When recording in VR mode, if a broadcast is bilingual, both audio channels are recorded, allowing you to switch the audio channel on playback. The only exception to this is when the picture quality is set to **LPCM**, in which case you do need to select the audio channel before recording.

### 5 Press ● REC to start recording.

If you want to set a recording end time, press the ● **REC** button repeatedly. The recording time increases in 30 minute increments, up to a maximum of six hours. The time the recording will end is shown on-screen and in the front panel display. When the recording ends, the recorder automatically switches into standby if no other operation is being performed.

- To cancel the set recording time, press ● **REC**.
- If you want to pause recording at any time, press **II PAUSE**. Press again to restart the recording. (If recording in VR mode, a new chapter is started after recording restarts)

### 6 To stop the recording, press □ STOP REC.

- If you set the recording time in the previous step, you can still stop the recording anytime by pressing □ **STOP REC**.
- Recording will stop automatically when there is no more space on the DVD.

## Setting a timer recording

**VR mode** **Video mode**

Using the timer recording features you can program up to 32 timer recordings up to a month in advance. Timer recording programs can be set to record just once, every day, or every week.

There are three ways to program a timer recording; using the Easy Timer Recording feature (see *Easy Timer Recording* below), using the G-Code programming system (see *Timer recording using the G-Code™ programming system* on page 36), or using manual timer recording (see *Setting a manual timer recording* on page 37).

You can set the recording quality for your timer recording in the same way as for a regular recording, but with the added option of an **AUTO** mode, which maximizes the recording quality for the space available on the disc.

You can also set the recorder so that it will adjust the recording quality to try and fit the recording on to the disc if it would not otherwise fit at the recording quality you set (see *Optimized Rec* on page 72 for more on this).

### Important

- A timer recording can't be set if:
  - Auto Start Recording is in progress.
  - There are already 32 timer programs waiting to be recorded.
- Timer recording will not start if:
  - The recorder is already recording.
  - A disc is being initialized, finalized or unfinalized.
- Except when finalizing Video mode discs, timer recording will start when the operation preventing timer recording has finished.
- Timer recording will start when the operation preventing timer recording has finished.
- If a recordable DVD that doesn't support simultaneous playback and recording (see *Simultaneous recording and playback* on page 40) is playing when a timer recording is due to start, playback will automatically stop to allow the recording to start.
- The timer indicator (Ⓢ) lights in the front panel display when the timer is active. If the indicator is blinking it means that there is no disc loaded, or the disc loaded is not recordable.
- Approximately two minutes before a timer recording is set to start, the recorder will go into timer recording standby. In timer recording standby you cannot use some functions.
- Timer recordings have higher priority than the Auto Start Recording function (see *Automatic recording from a satellite tuner* on page 42). A timer recording will interrupt an Auto Start Recording. (Auto Start Recording will resume after the timer recording has finished.)

## Easy Timer Recording

As the name suggests, Easy Timer Recording makes setting up a timer recording as simple as possible.

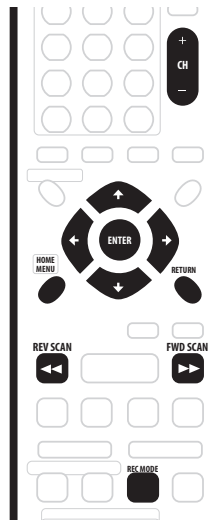

**1 Press HOME MENU and select 'Timer Recording' then 'Easy Timer'.**

**2 Set the TV channel and recording quality.**

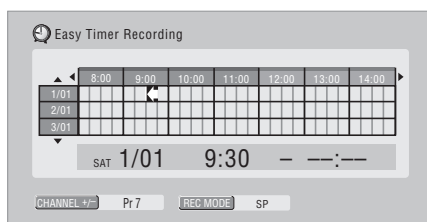

- Use the **CH +/-** buttons to set the channel you want to record.
- Use the **REC MODE** button to set the recording quality. Press repeatedly to switch between **XP**, **SP**, **LP**, **EP**, **SLP**, **SEP** and **AUTO** (and **MN** if manual recording mode is on).
- The **AUTO** option automatically sets the best recording quality for the space available on the disc loaded at the time of recording.

### 3 Use $\uparrow/\downarrow/\leftarrow/\rightarrow$ to move the cursor to the recording start date and time on the grid.

- You can move the cursor forward or back an hour at a time using the  $\leftarrow\leftarrow$  and  $\rightarrow\rightarrow$  buttons.

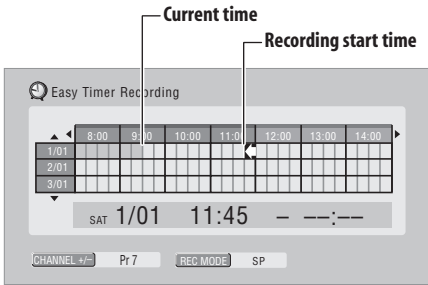

Each row of the grid is one day (you can set the timer recording for up to a month in advance). Each column is a 15 minute interval.

The darker area represents time that has already passed and can't therefore be selected. The lighter area is time that's available.

### 4 Press ENTER to set the start time.

The start date and time is displayed in the middle of the screen.

- You can go back and reset the start time if you need to by pressing RETURN.

### 5 Use the $\leftarrow/\rightarrow$ to move the cursor to the recording end time on the grid.

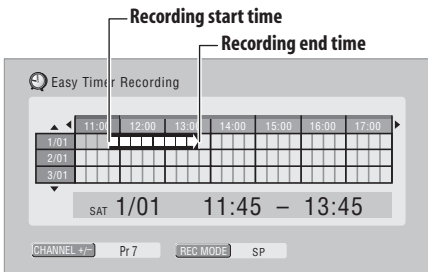

As you move the cursor around the grid, an arrow stretches from the start time to the current cursor position, representing the length of the recording. A recording of up to six hours can be set.

### 6 Press ENTER to set the end time.

### 7 Select 'Yes' to set the timer recording and exit, or 'No' to go back to the timer recording screen.

- You can check the timer recording details you just set from the main timer recording screen (see *Setting a manual timer recording* on page 37).

## Timer recording using the G-Code™ programming system

This system makes programming timer recordings very simple. Most TV guides publish G-Code programming numbers with their program details. If you want to make a timer recording of a program, you just input the corresponding code. The date, start, stop and channel settings are made automatically. All you have to do is tell the recorder the recording mode, and whether it's a once-only recording or a regular recording.

Note that if the country setting is incorrect (set in the Setup Navigator), timer recordings made using the G-Code programming system may not work as expected.

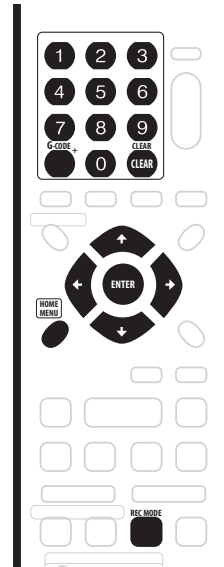

### 1 Press 'G-Code' to display the G-Code program screen.

You can also access this screen from the Home Menu (press HOME MENU, select **Timer Recording**, then **G-Code**).

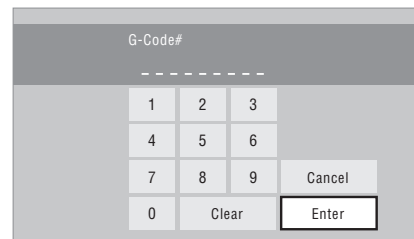

- Use the number buttons to enter the G-Code programming number. (To clear the last digit entered, press CLEAR.)

- You can also use the **↑/↓/←/→** buttons to select digits from the on-screen display.

## 2 After making the settings, select 'Enter' and press ENTER.

The timer recording screen appears with the timer program you just set.

## 3 Confirm that the settings are correct.

If the channel number isn't displayed, use the **←/→** buttons to highlight **CH**, then use the **↑/↓** buttons to set the correct channel number.

- If the channel number is set, but incorrectly, set up the guide channel (see *G-Code CH Setting* on page 69).

## 4 Select 'Store Program' to finish.

- Other options in the same menu panel allow you to name the program, and change the recording destination and/or recording mode.

## G-Code programming with the power off

You can enter a G-Code programming number when the recorder is in standby.



### Important

- You can't use this feature until you have set up the guide channels. See *G-Code CH Setting* on page 69.
- You can't change the recording mode.
- You can't program daily or weekly timer recordings.

## 1 Press 'G-Code'.

The front panel display shows the current recording mode and prompts you to enter the G-Code programming number.



## 2 Use the number buttons to enter the number.

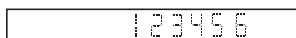

- To clear the last digit entered, press **CLEAR**.

## 3 Press ENTER.

The display shows the timer settings:

Date → Start time → End time → Recording channel → Recording mode.

- If **CODE ERROR** appears in the display, check that the number is correct and that the guide channel is set (see *G-Code CH Setting* on page 69), then set the timer recording again.
- If **CAN'T SET** appears in the display, it means that although you entered a valid number, the program has already finished.

## Setting a manual timer recording

The timer recording screen you can see all the timer programs already set, clear programs and set up new ones.

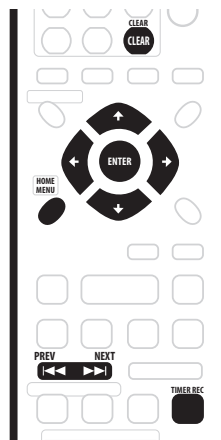

## 1 Press TIMER REC to display the Timer Recording screen.

You can also access the Timer Recording screen from the Home Menu (press **HOME MENU**, select **Timer Recording**, then **Timer Recording**).

This screen shows all the timer programs currently set.



- Each row is for one timer recording program, with the date and time information, channel, recording mode, and recording status.

- The amount of free space available and the currently loaded recordable DVD is shown towards the bottom of the screen.
- In the upper-right corner, the number of timer programs already set is shown next to **Tmr Pgms**.
- If there are more than five timer programs already set, press **NEXT** ►► to switch page (go back using the **PREV** ◄◄ button).
- You can also delete a timer program before it's started (before the recorder enters timer recording standby) by highlighting it and pressing **CLEAR**. See also *Deleting a timer program* on page 39.

## 2 Select 'New Input' to set a new timer program, then press ENTER.

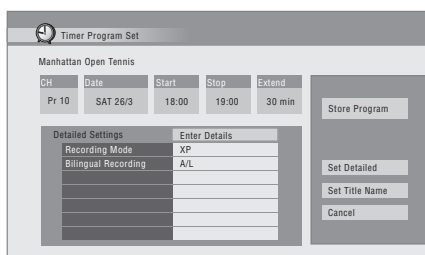

## 3 Enter the timer recording settings.

Use the ◀/▶ buttons to select a field; use the ↑/↓ buttons to change the value.

- **CH** – Choose a channel (Pr 1–Pr 99, excluding skip channels), or one of the external inputs from which to record.
- **Date** – Choose a date up to one month in advance, or select a daily or weekly program.
- **Start** – Set the recording start time.
- **Stop** – Set the recording end time.

## 4 If you want to change the recording mode, etc., select 'Set Detailed'.

In this area you can set:

**Recording Mode** – Select **XP**, **SP**, **LP**, **EP**, **SLP** or **SEP**, (See *Setting the picture quality/recording time* on page 33). If Manual Recording is on, then you can also select the **LPCM** setting, or **MN** (press **ENTER** then use the ◀/▶ buttons to select the level).

**Bilingual** – Select which channel of a bilingual broadcast to record (necessary if recording to a Video mode DVD).

## 5 After entering all the timer recording information, highlight 'Store Program' and press ENTER.

The timer recording list screen is displayed again. The timer program you just input appears in the list. The rightmost column shows various timer recording status messages:

- **OK** – Can be recorded.

- **Time Over** – Not enough space (the recording won't finish).
- **Overlap** – Two timer programs partially or completely overlap. The one starting earlier will take priority.
- **Until ...** (eg., **Until 13/8**) – For a regular recording, the last program that could be recorded is shown.
- **Data Over** – Can't record because the disc management area of the disc is full.
- **Cancel Once** – A regular timer program is set to skip.
- **Can't Rec** – Not possible to record.
- **Title Over** – Can't record because there is already the maximum number of titles on the disc (DVD: 99).
- **Recording** – The program is currently recording.
- **Standby** – The recorder is in timer recording standby.
- *nothing displayed* – Another timer recording is in progress.

## 6 To exit the timer recording screen, press HOME MENU.



### Tip

- To enter a title name for the timer recording in advance, select **Set Title Name** and follow the on-screen display.



### Note

- If the timer program is too long to fit into the available disc space, the message **Time Over** appears. The program will record until the disc is full.
- If **Optimized Rec** (see *Optimized Rec* on page 72) is set to **On**, the recorder will adjust the recording quality to try and fit the recording on the disc. If the program is too long even when recorded in **MN1** mode, the message **Time Over** appears.

### Editing a timer program

You can change any of the settings in a timer program before the recording is due to start.

- 1 Press **TIMER REC.**
- 2 Highlight the timer program you want to change.
- 3 Press **⇒** then select 'Modify' from the command menu panel.  
Alternatively, press **ENTER**.  
The Timer Program Set screen appears from which you can edit the settings.
- 4 Edit the timer recording settings as necessary.
- 5 Select 'Store Program' to finish.  
Confirm the settings you made from the following screen.

### Deleting a timer program

You can delete timer programs you no longer need.

- 1 Press **TIMER REC.**
- 2 Highlight the timer program you want to erase.
- 3 Press **⇒** then select 'Erase' from the command menu panel.
  - Select **Yes** to confirm or **No** to cancel.
  - You can also just press **CLEAR** when the timer program is highlighted.

### Skipping a regular timer program

If you've set a regular daily or weekly timer program, you can set the recorder to skip the next scheduled recording.

- 1 Press **TIMER REC.**
- 2 Highlight the timer program you want to skip.
- 3 Press **⇒** then select 'Cancel Once' from the command menu panel.
  - In the timer program list, **Cancel Once** appears by the program.
  - You can also just press **||** when the timer program is highlighted.

### Extending a timer recording in progress

You can extend a timer recording beyond the programmed end time in two different ways. This can be useful if a broadcast program overruns, for example.

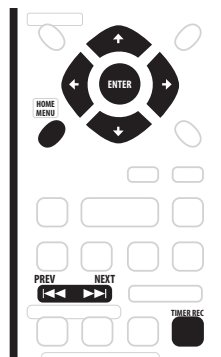

### Moving the end time by 30-minute blocks

- 1 During timer recording, press and hold **● REC** for three seconds.  
The timer indicator disappears from the front panel display.
- 2 Press **● REC** repeatedly to extend recording in 30 minute increments.

### Programming a new end time

You can edit the end time of a timer recording you have previously set.

- 1 Press **TIMER REC.**
- 2 Highlight the timer program you want to change.
- 3 Press **⇒** then select 'Modify' from the command menu panel.  
Alternatively, press **ENTER**.  
The Timer Program Set screen appears from which you can edit the settings.
- 4 Edit the end time as necessary.  
You can also edit the **Extend** time parameter.
- 5 Select 'Store Program' then press **ENTER**.
- 6 To exit the timer recording screen, press **HOME MENU**.

## Canceling and stopping a timer recording in progress

After a timer recording has started, you can cancel the program (but continue recording), or stop recording completely if you need to.

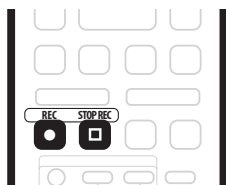

### 1 During timer recording, press and hold ● REC for three seconds.

Only the program is canceled (the timer indicator disappears); recording continues so that you can manually stop recording whenever you like.

### 2 When you want to stop recording completely, press □ STOP REC.



#### Tip

- You can also stop a timer recording immediately by pressing □ STOP REC then selecting **Yes** to confirm.

## Preventing use of the recorder before a timer recording (child lock)

You can make all the front panel and remote control buttons inoperative using the child lock feature. This is useful when you set a timer recording and want to make sure that the timer settings are not changed before recording has finished.

### 1 If the recorder is on, switch it into standby.

### 2 Press and hold ■ STOP on the front panel for three seconds to lock the controls.

The front panel display briefly shows **LOCK**. If any buttons are pressed on the remote or front panel, **LOCK** is briefly displayed again.

- To unlock the recorder, press and hold ■ STOP on the front panel for three seconds until the display shows **UNLOCK**.
- To cancel a timer recording when the recorder is locked, first unlock the recorder (see above), then press and hold ● REC for three seconds.

## Timer recording FAQ



### Frequently Asked Questions

- Even though the timer is set, the recorder doesn't start recording!*

Check that the disc loaded is recordable, not locked (see *Lock Disc* on page 63), and that there are fewer than 99 titles already on the DVD.

- The recorder won't let me enter a timer program! Why not?*

You can't enter a timer program if the clock isn't set.

- What happens when two or more timer programs overlap?*

Basically, the program with the earlier recording start time has priority. However, the recorder will start recording the program with the later start time after the earlier program is finished. If two programs have the same times, only one of them will be recorded, so it is best to set one of them to **Cancel Once**. See *Skipping a regular timer program* on page 39.

- I entered a timer program, but the recorder doesn't confirm whether or not it's OK. Why not?*

Timer confirmation only works for DVD recordings when there is a recordable disc loaded. Also make sure that the disc is not locked (see *The Disc Setup menu* on page 63) and that there are fewer than 99 titles already recorded. Note that it's possible that although the timer recording screen says OK, the recording doesn't complete successfully because of some other reason, such as a damaged disc, etc.

## Simultaneous recording and playback

### VR mode

A feature called Chase Play makes it possible to watch a recording in progress from the start of the recording (as in, playback is 'chasing' the recording). For example, perhaps you have to miss the first 30 minutes of a movie on TV; you can start recording, then start watching the movie, from the beginning, while the recorder is still recording 30 minutes ahead of you.

In fact, you're not just limited to watching the recording in progress; you can watch anything else already on the DVD by selecting it from the Disc Navigator screen (see *Using the Disc Navigator with recordable discs* on page 47).



### Important

- You must use a DVD-RW Ver. 1.1 / 2x or Ver. 1.2 disc to be able to use this feature.
- You may not be able to use this feature with a DVD-RW disc that was first initialized on another recorder.
- Chase playback is not possible using a VR mode DVD-R disc.
- You can't use this feature during Auto Start Recording, or in Auto Start Recording standby (the **AUTO** indicator is lit in the front panel display).
- **During recording, press ► PLAY to start playback from the beginning of the current recording<sup>1</sup>, or press DISC NAVIGATOR and select another title to play from there.**

You can use all the usual playback controls, such as pause, slow-motion play, scan<sup>2</sup> and skip.

- To stop playback, press ■ **STOP** (recording will continue).
- To stop recording, press □ **STOP REC** (playback will continue).
- During recording or in timer recording standby, you can't play a DVD or Video CD/Super VCD disc if the Input Line System setting doesn't match the TV line system of the disc (see also *Additional information about the TV system settings* on page 74). Also, during simultaneous recording and playback, if the TV line system of the playback track/title changes then playback will automatically stop.

## Recording from an external component

**VR mode** **Video mode**

You can record from an external component, such as a camcorder or VCR, connected to one of the recorder's external inputs.

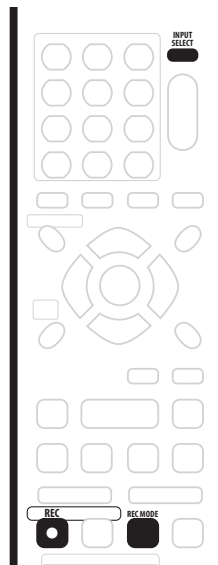

### 1 Make sure that the component you want to record from is connected properly to the DVD recorder.

See Chapter 2 (*Connecting up*) for connection options.

### 2 Press INPUT SELECT repeatedly to select one of the external inputs to record from.

There are three analog inputs and a DV digital input. The current input is shown on-screen and in the front panel display:

- **L1** – Input 1/Auto Start Rec
- **L2** – Input 2 (front panel)
- **L3** – Input 3
- **DV** – DV input (front panel)

Check that the **Audio In** settings for **External Audio**, **Bilingual Recording** and **DV Input** are as you want them (see *Audio In Settings* on page 69).

- If the aspect ratio is distorted (squashed or stretched), adjust on the source component or your TV before recording.

### Note

1. You can't start playback immediately after recording starts.

2. When scanning a DVD, no sound is output if the recorder is also recording (see *Scanning discs* on page 48).

### 3 Set up the recorder.

- Use **REC MODE** to set the recording quality. See *Setting the picture quality/recording time* on page 33 for detailed information.

### 4 Press **● REC** when you're ready to start recording.

- The recorder will only start recording from the **DV IN** jack if there is a valid signal. Recording will also pause if the signal is interrupted during recording.
- If your source is copy-protected using CopyGuard, you will not be able to record it. See *Restrictions on video recording* on page 33 for more details.

## Automatic recording from a satellite tuner

If you have a satellite tuner or some other kind of set top box connected to the **L1** input, you can have the recorder start and stop recording automatically with the timer settings of the connected component. (If the other component doesn't have a built-in timer, you'll need to use it with an external timer unit.)<sup>1</sup>

After setting up for Auto Start Recording, this recorder starts recording when it detects a signal from the other component. When the signal ceases, the recorder stops recording.

If you want to use this recorder with the timer features of your satellite tuner, see *Language code list* on page 82.



### Important

- It takes a little while for this recorder to switch on and start recording after detecting a signal. Please bear this in mind when setting the timer.
- If Auto Start Recording is set, it will not start if another timer recording is in progress.
- Timer recordings take precedence over Auto Start Recording. Auto Start Recording will stop if a timer recording is due to start. After the timer recording has finished, Auto Start Recording will resume.

### 1 Set the timer for the satellite receiver (or other component), then switch it into standby (if necessary).

Check the manual that came with the receiver if you're not sure how to do this.

### 2 Check that the 'Audio In' settings for 'External Audio' and 'Bilingual Recording' are as you want them.

See *Audio In Settings* on page 69 for more on these settings.

### 3 Set up the recorder.

- Use **REC MODE** to set the recording quality. See *Setting the picture quality/recording time* on page 33 for detailed information.

### 4 Press **HOME MENU** and select 'Timer Recording', then 'Auto Start Recording'.

### 5 Select 'Yes' to switch Auto Start Recording on, or 'No' to switch off.

### 6 Switch the recorder into standby.

The **AUTO** indicator in the front panel display lights.

The recorder will automatically switch on and start recording when the other component comes on.

Recording stops when the external component switches off.

- To cancel Auto Start Recording, press **⏻ STANDBY/ON** while the recorder is in standby. The **AUTO** indicator goes off.
- To cancel Auto Start Recording once recording has already started, press **● REC** for three seconds (this cancels Auto Start Recording, but recording continues), then **□ STOP REC** to stop recording.
- You can also stop recording by pressing **□ STOP REC** then selecting **Yes** to confirm.



### Tip

- Alternatively, with no OSD displayed, press and hold the front panel **□ STOP REC** button for more than three seconds to switch Auto Start Recording on directly. After switching on, switch the recorder into standby (step 6).

## Recording from a DV camcorder

**VR mode** **Video mode**

You can record from a DV camcorder connected to the **DV IN** jack on the front panel of this recorder. Using the recorder's remote, you can control both the camcorder and this recorder.

### Note

1. You can't set Auto Start Recording when:
- the recorder is recording or in timer recording standby.
  - there is no recordable disc loaded.
  - the disc loaded is locked.
  - the disc loaded already contains the maximum number of titles (99).

Before recording, make sure that the audio input for the **DV IN** jack is setup (see *DV Input* on page 70).

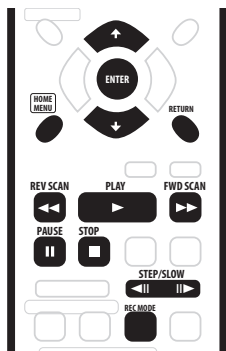

### Important

- The source signal must be DVC-SD format
- Some camcorders cannot be controlled using this recorder's remote.
- If you connect a second recorder using a DV cable, you cannot control the second unit from this one.
- You can't control this unit remotely from a component connected to the **DV IN** jack.
- You can't record date and time information from DV cassette.
- During DV recording, if a part of the tape is blank, or has copy-protected material on it, this recorder will pause recording. Recording will restart automatically when there is a recordable signal. However, if there is more than 10 seconds of blank tape, this recorder will stop recording and the camcorder should stop (depending on the camcorder).
- For best results when recording from a DV camcorder to this recorder, we recommend cueing the camcorder to the place you want to start recording from and setting the camcorder to play-pause.

#### 1 Make sure your digital camcorder is connected to the front panel **DV IN** jack.

Also, set the camcorder to VTR mode.

#### 2 Set up the recorder.

- Use **REC MODE** to set the recording quality. See *Setting the picture quality/recording time* on page 33 for detailed information.

#### 3 Load a recordable disc into the recorder.

#### 4 From the Initial Settings menu, check that the **DV audio input** is setup as you require.

See *DV Input* on page 70 for more on this.







- Check also that the **Audio In** settings for **External Audio** and **Bilingual Recording** are as you want them (see *Audio In Settings* on page 69).

#### 5 Press **HOME MENU** and select '**DV Record**' from the menu.

- DV recording only works when the digital camcorder is in VTR mode with a tape loaded.

#### 6 Find the place on the camcorder tape that you want to start recording from.

For best results, pause playback at the point from which you want to record.

- Depending on your camcorder, you can use this recorder's remote to control the camcorder using the , , , , ,  and  buttons.

#### 7 Use the **↑/↓** buttons to select '**Start Rec**' and press **ENTER**.

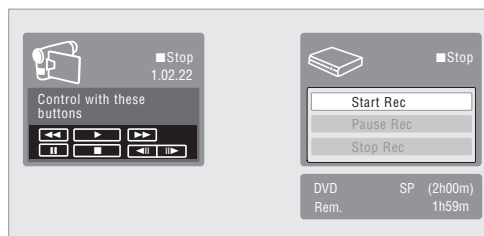

- Recording is automatically paused if the recorder detects no signal, or a copy-protected signal. Recording restarts when there is a non-copy-protected signal.
- You can pause or stop the recording by selecting **Pause Rec** or **Stop Rec** from the on-screen display. You cannot control the camcorder from this remote control during recording.
- If you restart recording after stopping the camcorder, the first few seconds of the camcorder tape will not be recorded. Use the pause button on your camcorder instead and recording will start immediately.
- *DVD-RW (VR Mode) only:* A chapter marker is inserted every time there is a break in the timecode on the DV tape. This happens when the recording is stopped or paused then restarted, for example.
- While recording, you cannot exit the DV recording screen using the **HOME MENU** or **RETURN** button.
- See also *DV-related messages* on page 80 if you encounter an error while using the **DV IN** jack.



### Frequently Asked Questions

- *I can't get my DV camcorder to work with the recorder!*  
Check that the DV cable is properly connected. Also make sure that what you're trying to record is not copy-protected.  
If it still doesn't work, try switching off the camcorder then switch back on.
- *There's a picture, but no sound!*  
Try switching the **DV Input** setting (see *DV Input* on page 70) between **Stereo 1** and **Stereo 2**.<sup>1</sup>

## Playing your recordings on other DVD players

**VR mode** **Video mode**

Most regular DVD players can play finalized discs recorded in Video mode. A number of players (including many Pioneer models) can also play DVD-RW discs recorded in VR mode, finalized or not. Most players will not play VR mode DVD-R discs, although some DVD-ROM drives and DVD recorders may be able to (finalization might be necessary). Check the manual that came with the player to check what kinds of discs it will play.

When you finalize a Video mode disc, a title menu is created from which you can select titles when you play the disc. There are a number of different styles of title menu to choose from to suit the content of the disc.

All the title menus are navigated in the usual way, pressing **MENU** or **TOP MENU** to display the menu, then using the **↑/↓/←/→** followed by **ENTER** to select titles and start playback.

### Finalizing a disc

**VR mode** **Video mode**

Finalizing 'fixes' the recordings in place so that the disc can be played on a regular DVD player or computer equipped with a suitable DVD-ROM drive.

Note that the disc name will appear in the title menu after you finalize a disc. Make sure the disc name is as you want it before you finalize the disc as it can't be changed afterwards. If you want to rename the disc, see *Input Disc Name* on page 63 before starting the steps below.



### Important

- Once you've finalized a disc recorded in Video mode, you can't edit or record anything else on that disc. However, the finalization on a DVD-RW disc maybe 'undone'; see *Undo Finalize* on page 64 for how to do this.
- A VR mode disc can still be recorded and edited on this recorder even after finalizing.

#### 1 Load the disc you want to finalize.

Make sure that the recorder is stopped before proceeding.

#### 2 Press HOME MENU and select 'Disc Setup'.

#### 3 Select 'Finalize'.

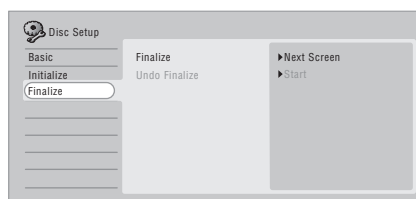

#### 4 Select 'Finalize' from the finalize options, then 'Next Screen'.

#### 5 For Video mode discs only, select a title menu style, then select 'Yes' to start finalization or 'No' to cancel.

The menu you select will be the one that appears when the 'top menu' is selected on any DVD player.

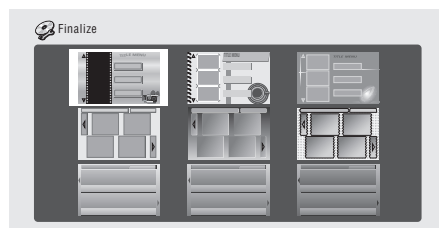

- Discs recorded partially or fully on the Pioneer DVR-7000 DVD recorder do not support this feature. These discs will have only a text title menu when finalized on this recorder.

#### 6 The recorder will now start finalizing the disc.

During finalization:

- If the finalization process of a DVD-RW disc is going to take more than around four minutes, you can press **ENTER** to cancel. Around four minutes before completion, the option to cancel disappears.

### Note

1. If the audio subcode on the DV tape cannot be read correctly, the audio type will not switch automatically. You can switch the audio manually from the **External Audio** setting (page 70).

- You can't cancel the finalization of a VR mode DVD-R disc.
- How long finalization takes depends on the type of disc, how much is recorded on the disc and the number of titles on the disc. A disc recorded in VR mode can take up to one hour to finalize. A disc recorded in Video mode can take up to 20 minutes.

### Note

- If the TV line system of the disc is different to the current setting of the recorder, you will not be able to finalize the disc. See *Additional information about the TV system settings* on page 74 for how to change the recorder's setting.

### 3 Select 'Video Mode' or 'VR Mode' from the initialize options.

### 4 Select 'Start'.

It takes about 30 seconds to initialize the disc.

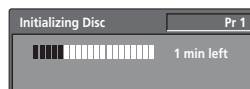

## Initializing a recordable DVD disc

When you first load a blank disc, the recorder will initialize it automatically for recording. You can also manually initialize discs for either Video mode recording or VR mode recording.<sup>1</sup>

By default, the recorder initializes blank DVD-RW discs for VR mode recording. See *DVD-RW Auto Init.* on page 72 if you want to change the default to Video mode.

DVD-R discs are ready for Video mode recordings out of the box; if you want to use a DVD-R for VR mode recording, you must do it before recording anything else on the disc.

### Important

- Initializing a DVD-RW disc will erase everything recorded on it. Make sure there is nothing on the disc that you want to keep!
- You may not be able to re-initialize a DVD-RW disc in a different format if it was originally initialized on an older DVD recorder.
- Once initialized for VR mode recording, you can't re-initialize a DVD-R back to Video mode.

### 1 Press HOME MENU and select 'Disc Setup'.

### 2 Select 'Initialize'

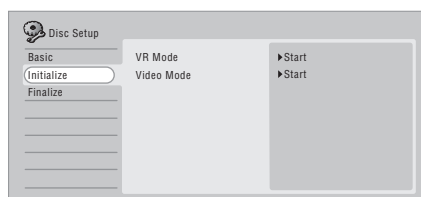

### Note

1. If a disc was previously finalized on an older DVD recorder, you may not be able to re-initialize and/or initialize it for Video mode recording.

## Chapter 6

# Playback

### Introduction

Most of the features described in this chapter make use of on-screen displays. Navigate these using the **↑/↓/←/→** and **ENTER**. To go back one level from any screen, use the **RETURN** button. Remember also that the button guide at the bottom of every screen shows which buttons do what.

Many of the functions covered in this chapter apply to DVD discs, Video CDs, Super VCDs, WMA/MP3 discs and CDs, although the exact operation of some varies slightly with the kind of disc loaded. The following icons are provided to help you quickly identify which instructions you need for which kind of disc.

- DVD** Any kind of DVD, DVD-R or DVD-RW
- DVD-Video** Commercially produced DVD or finalized Video mode DVD-R/RW
- Video mode** Video mode DVD-R/RW (unfinalized)
- VR mode** VR mode DVD-R/RW
- CD** Audio CD
- Video CD** Video CD
- Super VCD** Super VCD
- WMA/MP3** WMA or MP3 files

- Some DVD-Video discs don't allow certain playback controls to operate at certain points in the disc. This is not a malfunction.
- When playing Video CDs, some functions, such as making a program list, are not available in PBC mode. Stop the disc first, then start playback by pressing **▶▶**.
- For discs that contain JPEG picture files, see *The PhotoViewer* on page 61.

### Navigating discs

#### ALL

During playback you can easily jump to another title, chapter or track on a disc using the number buttons on the remote.

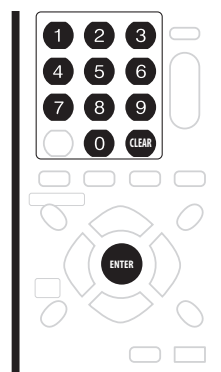

#### DVD-Video Video mode

**1 During playback use the number buttons to enter a chapter number within the current title.**

For example, for chapter 6, press **6**; for chapter 24, press **2**, then **4**.

- To clear and start again, press **CLEAR**.

**2 Optionally: Press ENTER.**

- Alternatively, just wait a few seconds and playback will jump to the new chapter.

#### VR mode

**1 During playback, use the number buttons to input a title number.**

For example, for title 6, press **6**; for title 24, press **2**, then **4**.

- To clear and start again, press **CLEAR**.

**2 Optionally: Press ENTER.**

- Alternatively, just wait a few seconds and playback will jump to the new title.

CD Video CD Super VCD WMA/MP3

## 1 During playback, use the number buttons to input a track number.

For example, for track 6, press **6**; for track 24, press **2**, then **4**.

- To clear and start again, press **CLEAR**.

## 2 Optionally: Press ENTER.

- Alternatively, just wait a few seconds and playback will jump to the new track.

- Use the **◀◀/▶▶** buttons to display the previous/next page of titles, if there are more titles than can fit on to the screen.
  - You can change the style and order in which titles are displayed from the view options menu. See below for more on this.
  - You can change the thumbnail picture displayed for a title; see *Set Thumbnail* on page 57.
- ## 3 To play the highlighted title, press ENTER.
- You can also select **Play** from the command menu options.

## Using the Disc Navigator to browse the contents of a disc.

Use the Disc Navigator to browse the contents of a disc and start playback.

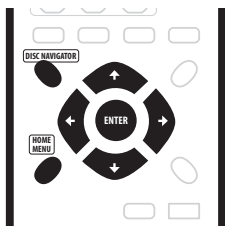

## Using the Disc Navigator with recordable discs

VR mode Video mode

You can use the Disc Navigator to browse and edit video on recordable DVDs, and to view information on titles.

See also *Editing* on page 54 for more on editing recordable discs.

## 1 Press HOME MENU and select 'Disc Navigator' from the on-screen display.

Alternatively, you can press **DISC NAVIGATOR** to go straight to the Disc Navigator screen.

## 2 Use the ↑/↓ buttons to browse up and down the list of titles.



### Tip

- Use the time search feature to find a particular point on a DVD. See *Search Mode* on page 50 for more information.

## Changing the display style of the Disc Navigator

You can choose to display titles in the Disc Navigator in various different ways, sorted alphabetically, by recording date, by genre, and so on. You can also choose whether to display four or eight titles on the screen at the same time.

## 1 From the Disc Navigator's title list, press ← to display the view options panel.

### The View Options panel

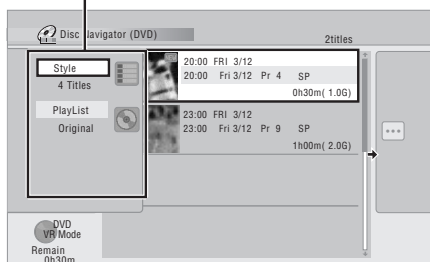

## 2 Use the ↑/↓ buttons to select 'Style', then press ENTER to see the available view options.

- **Style** – Select four or eight titles per screen view

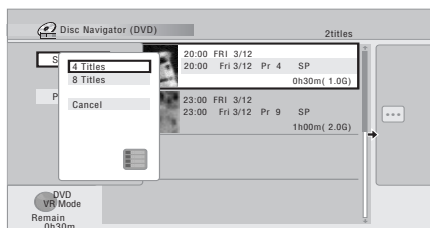

### 3 Use the **↑/↓** buttons to select an option, then press **ENTER**.

The title list display is updated according to the new display preferences.

### 4 Press **→** to return to the title list.

## Using the Disc Navigator with playback-only discs

**DVD-Video** **CD** **Video CD** **Super VCD** **WMA/MP3**

### 1 Press **HOME MENU** and select 'Disc Navigator' from the on-screen display.

Alternatively, for a CD, Video CD, Super VCD or WMA/MP3 disc, you can press **DISC NAVIGATOR**, which takes you straight to the Disc Navigator screen.



### 2 Select what you want to play.

Use the **↑/↓/←/→** to highlight items and **ENTER** to select.

Depending on the type of disc you have loaded, the Disc Navigator looks slightly different.

- When a DVD is loaded, titles are shown on the left, chapters on the right. Select a title, or a chapter within a title.
- When a CD or Video CD/Super VCD<sup>1</sup> is loaded, a list of the tracks is displayed.
- When a WMA/MP3 disc is loaded, a list of folders and tracks is displayed (as shown below). Select a folder or a track within a folder.

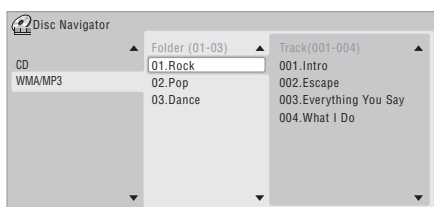

#### Note

1. It's not possible to use the Disc Navigator when playing a Video CD/Super VCD in PBC mode.
2.
  - Only analog audio is output when scanning audio CDs.
  - No subtitles are displayed when scanning DVDs.
  - Analog and digital sound is output when scanning DVDs with Dolby Digital or Linear PCM sound on forward **SCAN 1**. (Linear PCM is output from the optical digital output, Except during chase playback and simultaneous recording/playback) No sound is output when using other scan speeds.
  - Depending on the disc, normal playback may automatically resume when a new chapter is reached on a DVD disc.
3. Depending on the disc, reverse playback may not be smooth.

Playback starts after you press **ENTER**.

- For discs that contain both CD-Audio tracks and WMA/MP3 tracks, you can switch the playback area between **CD** and **WMA/MP3**. This can only be done while the disc is stopped.

## Scanning discs

You can fast scan discs at various speeds, forwards or backward.<sup>2</sup>



### 1 During playback, press **◀** or **▶** to start reverse or forward scanning.

- The scanning speed is shown on-screen.

### 2 Press the same button repeatedly to increase the scanning speed.

#### DVD

- **Forward:**  
**SCAN 1** (1.5x Quick View) → **SCAN 2** → **SCAN 3** → **SCAN 4**
- **Reverse:**  
**Reverse play**<sup>3</sup> → **SCAN 1** → **SCAN 2** → **SCAN 3** → **SCAN 4**

#### CD Video CD Super VCD WMA/MP3

- **Forward/Reverse:**  
**SCAN 1** → **SCAN 2**
- ### 3 To resume normal playback, press **▶ PLAY**.



## Playing in slow motion

DVD Video CD Super VCD

You can play video at various slow motion speeds. DVDs can be played in slow motion in either direction, while Video CD/Super VCDs can only be played forwards in slow motion.<sup>1</sup>

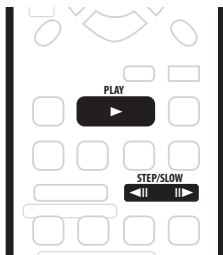

- 1 Press ◀◀ or ▶▶ to start slow motion reverse or forward playback.
- 2 Press the same button repeatedly to change the slow motion speed.

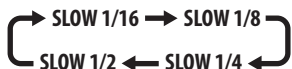

- 3 To resume normal playback, press ▶ PLAY.

## Frame advance/frame reverse

DVD Video CD Super VCD

You can advance or back up video on a DVD disc frame-by-frame. With Video CD/Super VCDs, you can only use frame advance.<sup>2</sup>

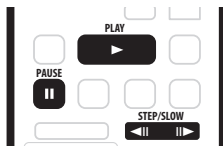

- 1 During playback, press || PAUSE.
- 2 Press ◀◀ or ▶▶ to back up or advance one frame.
  - Hold down ◀◀ or ▶▶ for continuous frame reverse/frame advance.
- 3 To resume normal playback, press ▶ PLAY.

### Note

1.
  - The picture quality during slow motion playback is not as good as during normal playback and depends on the disc being played.
  - Reverse slow-motion playback may not be as smooth as forward and may be better with some discs than others.
  - Depending on the disc, normal playback may automatically resume when a new chapter is reached on a DVD disc.
  - No sound is output during slow-motion playback.
2.
  - The picture quality when using frame reverse is not as good as frame advance.
  - Depending on the disc, normal playback may automatically resume when a new chapter is reached on a DVD disc.

## The Play Mode menu

ALL

The Play Mode menu gives you access to search functions, repeat and program play functions.

### Important

- You can't use the Play Mode features with Video CD/Super VCDs playing in PBC mode, or while a DVD disc menu is being displayed. For other restrictions, see the following sections.

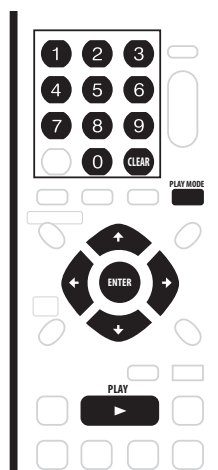

- 1 Press PLAY MODE to display the Play Mode menu screen.

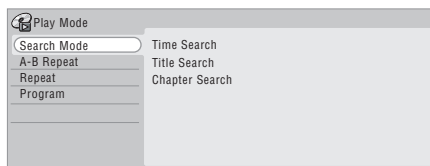

- You can also access the Play Mode menu from the Home Menu (press HOME MENU).
- 2 Use the ↑/↓/←/→ and ENTER to navigate.
    - To exit the Play Mode menu, press HOME MENU or PLAY MODE.

## Search Mode

ALL

The Search Mode feature lets you start playback from a specified point in a disc by time<sup>1</sup> or by title/chapter/folder/track number.

- 1 Select 'Search Mode' from the Play Mode menu.
- 2 Select one of the search options.
- 3 Use the number buttons to enter a title/chapter/folder/track number or the search time (in hours, minutes & seconds).

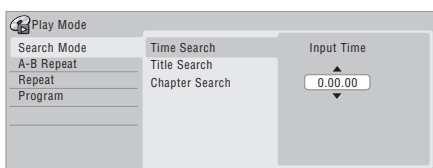

*Time Search (DVD):* For example, for 25 minutes into the current title, press **2, 5, 0, 0**. For 1 hour and 15 minutes and 20 seconds into the title, press **1, 1, 5, 2, 0**.

*Time Search (Video CD):* For example, for 2 minutes and 30 seconds into the current track, press **2, 3, 0**.

*Title/Chapter/Folder/Track Search:* For example, for track 6, press **6**. Alternatively, you can use the **↑/↓** buttons.

- 4 Press **ENTER**.

### Tip

- You can often select what you want to watch on a DVD disc from the disc menu. Press **MENU** or **TOP MENU** to display the disc menu.
- Time search doesn't work with CDs and Super VCDs.

## A-B Repeat

DVD

CD

Video CD

The A-B Repeat function allows you to specify two points (A and B) within a track or title that form a loop which is played over and over.<sup>2</sup>

- 1 During playback, select 'A-B Repeat' from the Play Mode menu.

- 2 With 'A (Loop Start)' highlighted, press **ENTER** at the point you want the loop to start.

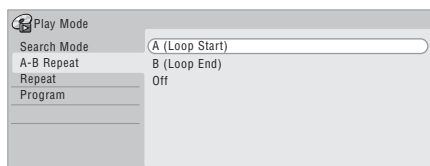

After setting the loop start point, the highlight will automatically move down to **B (Loop End)**.

- 3 With 'B (Loop End)' highlighted, press **ENTER** at the point you want the loop to end.

Playback immediately jumps back to the start point and plays the loop round and round.

- When playing a DVD-Video/Video mode DVD, the start and end points of the loop must be in the same title.

- 4 To resume normal playback, select 'Off' from the A-B Repeat menu.

- You can also press **CLEAR** to cancel A-B Repeat play if no menu OSD (such as the Play Mode menu) is displayed.

## Repeat play

ALL

There are various repeat play options, depending on the kind of disc loaded. It's also possible to use repeat play together with program play to repeat the tracks/chapters in the program list (see *Program play* on page 51).<sup>3</sup>

- 1 Select 'Repeat' from the Play Mode menu.
- 2 Select a repeat play mode.

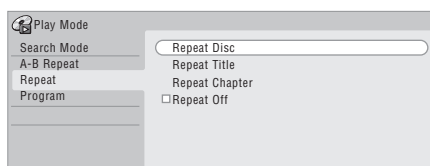

VR mode

- For VR mode DVD discs, select **Repeat Disc**, **Repeat Title** or **Repeat Chapter** (or **Repeat Off**).

### Note

1. When using time search, playback may occasionally start slightly before or after the time you input.
2. If you switch camera angles during A-B repeat play, A-B repeat is canceled.
  - You can't use A-B Repeat with WMA/MP3 or Super VCD discs.
3. If you switch the camera angle during repeat play of a DVD-Video disc, repeat play is canceled.

**DVD-Video** **Video mode**

- For DVD-Video and Video mode DVD discs, select **Repeat Title** or **Repeat Chapter** (or **Repeat Off**).

**CD** **Video CD** **Super VCD**

- For CDs and Video CD/Super VCDs, select **Repeat Disc** or **Repeat Track** (or **Repeat Off**).

**WMA/MP3**

- For WMA/MP3 discs, select **Repeat Disc**, **Repeat Folder** or **Repeat Track** (or **Repeat Off**).

**3 To resume normal playback, select 'Repeat Off' from the Repeat Play menu.**

- You can also press **CLEAR** to cancel repeat play if no menu OSD (such as the Play Mode menu) is displayed.

## Program play

**DVD-Video** **CD** **Video CD** **Super VCD** **WMA/MP3**

This feature lets you program the play order of titles/chapters<sup>1</sup>/folders/tracks on a disc.

- 1 Select 'Program' from the Play Mode menu.**
- 2 Select 'Input/Edit Program' from the list of program options.**

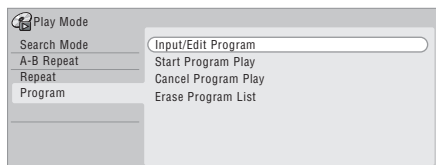

The Program edit screen that appears depends on the kind of disc loaded.

On the left side is the program list, then to the right is a list of titles (DVD), folders (WMA/MP3), or tracks (CD, Video CD/Super VCDs). On the far right is a list of chapters (DVD) or tracks (WMA/MP3).

**3 Select a title, chapter, folder or track for the current step in the program list.**

*DVD:* You can add a whole title, or a chapter within a title to the program list.

- To add a title, select the title.

- To add a chapter, first highlight the title, then press **➡** and select a chapter from the list.

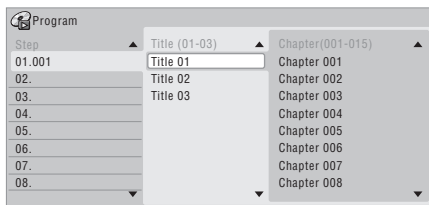

*CD or Video CD/Super VCD:* Select a track to add to the program list.

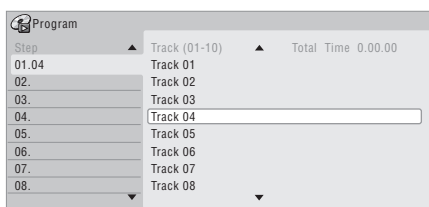

*WMA/MP3:* You can add a whole folder, or a track within a folder to the program list.

- To add a folder, select the folder.
- To add a track, first highlight the folder, then press **➡** and select a track from the list.

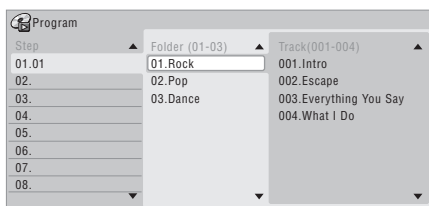

After pressing **ENTER** to add the title/chapter/folder/track, the step number automatically moves down one.

- To insert a step into the program list, highlight the step number where you want to insert another step, then select a chapter/title/folder/track as usual. After pressing **ENTER**, all the subsequent steps move down one.
- To delete a step from the program list, highlight the step you want to delete, then press **CLEAR**.

**4 Repeat step 3 to build up a program list.**

A program list can contain up to 24 titles/chapters/folders/tracks.

**Note**

1. When playing a program list of DVD-Video chapters, chapters not included in the program list may be sometimes be played, depending on the disc.

### 5 To play the program list, press ► **PLAY**.

Program play remains active until you turn off program play (see below), erase the program list (see below), eject the disc or switch off the recorder.

- You can use repeat play with program play. Start playback of the program list then select **Program Repeat** from the Repeat Play Mode menu (see *Repeat play* on page 50).



#### Tip

- To save your program list and exit the program edit screen without starting playback, press **HOME MENU** or **PLAY MODE**.
- You can change the program list by selecting **Input/Edit Program** from the Play Mode Program menu.
- During program play, press ►► to skip to the next program step.
- Press **CLEAR** during playback to switch off program play (if no menu OSD, such as the Disc Navigator, is displayed). Press while stopped to erase the program list.

### Other Program play functions

As well as creating and editing a program list, you can start program play, cancel program play, and erase the program list from the Play Mode menu.

#### 1 Press **PLAY MODE** and select 'Program' from the list of functions on the left.

#### 2 Select a program play function.

- Input/Edit Program** – See above
- Start Program Play** – Starts playback of a saved program list
- Cancel Program Play** – Turns off program play, but does not erase the program list
- Erase Program List** – Erases the program list and turns off program play

## Displaying and switching subtitles

### DVD-Video

Some DVD discs have subtitles in one or more languages; the disc box will usually tell you which subtitle languages are available. You can switch subtitle language during playback.<sup>1</sup>

Check the disc packaging for details of the subtitle options.

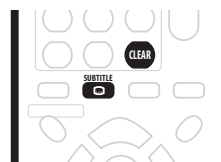

#### 1 Press **SUBTITLE** repeatedly to select a subtitle option.

The current subtitle language is shown on-screen and in the front panel display.

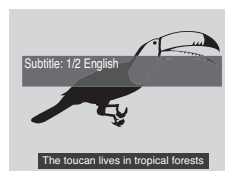

#### 2 To switch off subtitles, press **SUBTITLE** then **CLEAR**.

## Switching DVD soundtracks

### DVD-Video

When playing a DVD disc recorded with two or more soundtracks (often in different languages), you can switch the soundtrack during playback.<sup>2</sup>

Check the disc packaging for details of the soundtrack options.

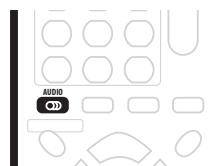

### Note

- Some discs only allow you to change subtitle language from the disc menu. Press **TOP MENU** or **MENU** to access.
  - To set subtitle preferences, see *Subtitle Language* on page 71.
- Some discs only allow you to change audio language from the disc menu. Press **TOP MENU** or **MENU** to access.
  - To set audio language preferences, see *Audio Language* on page 71.

- Press **AUDIO** repeatedly to select an audio soundtrack.

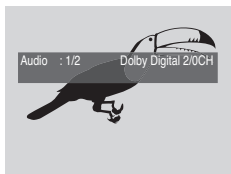

- The sound may drop out for a few seconds when switching soundtracks.
- Some discs feature both Dolby Digital and DTS soundtracks. There is no analog audio output when DTS is selected. To listen to the DTS soundtrack, connect this recorder to a DTS decoder or AV amp/receiver with built-in DTS decoder via the digital output. See *Connecting to an AV amplifier or receiver* on page 17 for connection details.

## Switching audio channels

**VR mode** **CD** **Video CD** **Super VCD** **WMA/MP3**

For VR mode content recorded with bilingual audio, you can switch between left (**L**) channel, right (**R**) channel, or both (**L+R**).<sup>1</sup>

When playing Video CDs and audio CDs you can switch between stereo, just the left channel or just the right channel.

Some Super VCDs have two soundtracks. With these discs you can switch between the two soundtracks as well as individual channels in each.



### 1 To display/switch the audio channel, press **AUDIO** repeatedly.

The audio channel(s) currently playing are indicated on-screen.

**VR mode**

- **L+R** – Both channels (default)
- **L** – Left channel only
- **R** – Right channel only

#### Note

<sup>1</sup> When playing a Bilingual recording on a VR mode disc, if you are listening to the Dolby Digital soundtrack via the digital output, you cannot switch the audio channel. Set **Dolby Digital Out** to **Dolby Digital** → **PCM** (see *Dolby Digital Out* on page 70) or listen via the analog outputs if you need to switch the audio channel.

**CD** **Video CD** **WMA/MP3**

- **Stereo** – Stereo (default)
- **1/L** – Left channel only
- **2/R** – Right channel only

**Super VCD**

- **1 Stereo** – Soundtrack 1 / Stereo (default)
- **1 L** – Soundtrack 1 / Left channel
- **1 R** – Soundtrack 1 / Right channel
- **2 Stereo** – Soundtrack 2 / Stereo
- **2 L** – Soundtrack 2 / Left channel
- **2 R** – Soundtrack 2 / Right channel

## Switching camera angles

**DVD-Video**

Some DVD-Video discs feature scenes shot from two or more angles—check the disc box for details: it should be marked with a  icon if it contains multi-angle scenes. When a multi-angle scene is playing, the same icon appears on screen to let you know that other angles are available (this can be switched off if you prefer—see *Angle Indicator* on page 73).

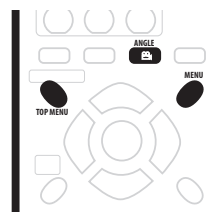

- To switch the camera angle, press **ANGLE**.
- The angle number is displayed on-screen.
- If the disc was paused, playback starts again with the new angle.
- Repeat play is canceled if you change the angle while repeat playback is active.
- You can also change the angle from some DVD-Video disc menus. Press **TOP MENU** or **MENU** to access.

## Chapter 7

# Editing

### The Disc Navigator screen

The Disc Navigator screen is where you can edit video content on unfinalized Video mode and VR mode DVD discs<sup>1</sup>.

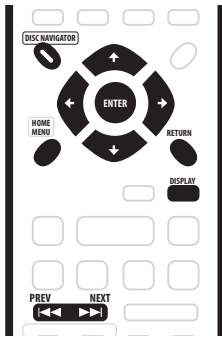

#### 1 Press DISC NAVIGATOR to display the Disc Navigator screen.

Playback will automatically stop when you do this.

- If you are editing a VR mode disc you can display the Play List by selecting **Play List** from the view options panel (press **←**, then select **Play List** from the view options, then **Play List**).

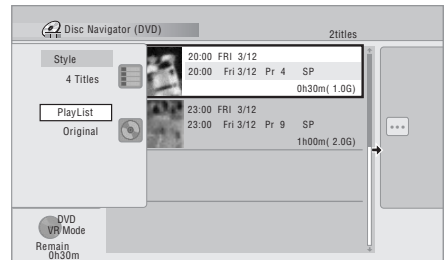

#### 2 To exit the Disc Navigator, press HOME MENU.

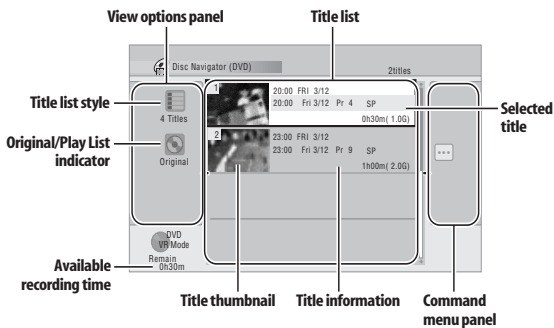

- You can also access the Disc Navigator from the Home Menu (press **HOME MENU**, select **Disc Navigator** then press **ENTER**).
- From the title list, press **→** to display the command menu panel. Use the **↑/↓** and **ENTER** buttons to navigate the menus.
- When in the title list, use the **PREV** (**←←**) and **NEXT** (**→→**) buttons to display the previous/next page if there are more titles than can be displayed.
- Press **DISPLAY** to change the title information displayed in the title list.

#### Note

1. It isn't possible to edit video on DVD-RAM discs using this recorder.

## Command menu panel options

The table below shows which commands you can use with which video type.

	Video mode	VR mode (Original)	VR mode (Play List)
<b>Create</b> (page 55)			●
<b>Play</b> (page 55)	●	●	●
<b>Erase</b> (page 56)	●	●	●
<b>Edit &gt; Title Name</b> (page 56)	●	●	●
<b>Edit &gt; Set Thumbnail</b> (page 57)	●	●	●
<b>Edit &gt; Erase Section</b> (page 57)		●	●
<b>Edit &gt; Divide</b> (page 58)			●
<b>Edit &gt; Chapter Edit</b> (page 58)		●	●
<b>Edit &gt; Lock</b> (page 58)	●	●	
<b>Edit &gt; Move</b> (page 59)			●
<b>Edit &gt; Combine</b> (page 59)			●
<b>Undo</b> (page 60)	●	●	●

### Create

**VR mode** *Play List only*

Use this function to create a Play List and add titles to it. Before you can use this command, make sure that the Play List is switched on in the view options panel on the left.

- 1 Select 'Create' from the command menu panel.

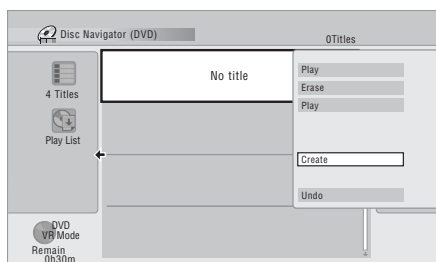

- 2 Select a title to add to the Play List.

Use the **↑/↓** buttons to highlight an Original title then press **ENTER** to add it and display the Play List.

- 3 Repeat steps 1 and 2 to add as many titles as necessary to the Play List.

### Play

**Video mode** **VR mode**

Use this function to start playback of a title.

- 1 Highlight the title you want to play.
- 2 Select 'Play' from the command menu panel. Playback of the title you selected starts.

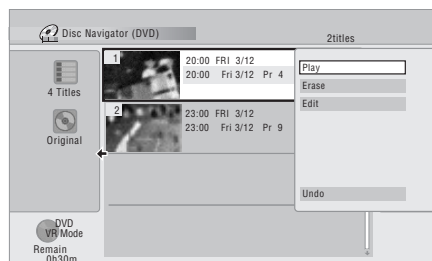

## Erase

**Video mode** **VR mode**

Use this function to erase unwanted titles.

When you erase titles from the Original titles from a VR mode DVD-RW, the available recording space increases accordingly. Erasing a title from a Video mode DVD-RW disc increases the available recording time only if it is the last title on the disc.

Erasing Play List titles, or titles from a DVD-R, VR mode or Video mode, will not result in any more free space on the disc.

- 1 Highlight the title you want to erase.
- 2 Select 'Erase' from the command menu panel.
- 3 Select 'Yes' to confirm or 'No' to cancel, then press **ENTER**.



### Tip

- You can erase a title quickly by pressing **CLEAR** when the title is highlighted. Confirm the edit by pressing **ENTER**.

## Title Name

**Video mode** **VR mode**

You can give titles new names of up to 64 characters long for VR mode recordings, and up to 40 characters for Video mode recordings.

- 1 Highlight the title you want to name (or rename).
- 2 Select 'Edit' > 'Title Name' from the command menu panel.

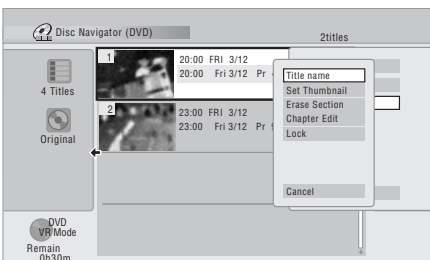

- 3 Input a name for the selected title.

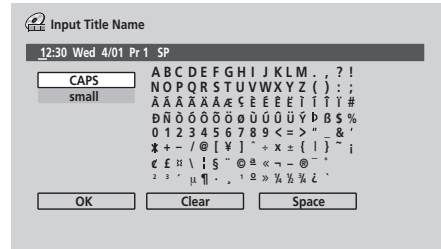

- Use the **↑/↓/←/→** and **ENTER** to select characters.
  - A name generated automatically by the recorder will already be in the name input section of the screen. Use the **◀/▶** buttons to change the cursor position.
  - Select **CAPS** or **small** to change to upper or lower case, or use the **CASE SELECTION** buttons (**◀/▶**).
  - You can also use the **CLEAR** button to delete characters directly (press and hold for two seconds to delete the whole name). For other remote control key shortcuts, see *Using the remote key shortcuts to input a name* below.
  - For discs formatted on a different DVD recorder, you will see only a limited character set.
- 4 Highlight 'OK' then press **ENTER** to enter the name and return to the main Disc Navigator screen.
    - To return to the main Disc Navigator screen without saving changes to the title name, press **RETURN**.

### Using the remote key shortcuts to input a name

The table below shows the remote control key shortcuts that you can use to input characters in the name input screen. Pressing a button repeatedly cycles through the characters shown.

If you want to enter two characters in succession that are both on the same button (for example a **P** and an **R**), press **▶▶** to advance the cursor one space manually between inputting the two characters.



Key	Characters	Key	Characters
1	, ' ?   - & 1	6	m n o 6 ö ò ó ø ñ
2	a b c 2 ä å á â ã æ ç	7	p q r s 7 \$ ÿ / ß *1
3	d e f 3 è é ê ë	8	t u v 8 ü ú û ü
4	g h i 4 î ï ð	9	w x y z 9
5	j k l 5 £	0	0
◀◀	[cursor back]	▶▶	[cursor forward]
◀◀/▶▶	[change case]	CLEAR	[clear character]
⏏	<space>	■	[finish name input]
+	~ ( ) _ / : ; " ` ^ @ # * % ¥   + = { } [ ] < >		

\*1 lower-case: ÿ; upper-case: ß

### Set Thumbnail

Video mode VR mode

You can change the thumbnail picture that appears in the Disc Navigator for a title to any frame that appears in that title.

- 1 Highlight the title you want to change the thumbnail picture for.
- 2 Select 'Edit' > 'Set Thumbnail' from the command menu panel.

The thumbnail setting screen appears from which you can find the frame you want.

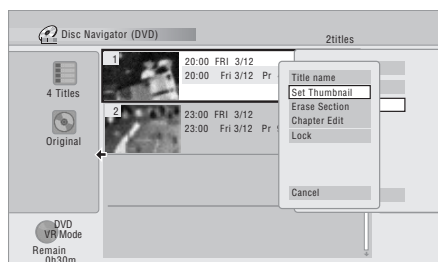

- 3 Use the playback controls (▶, ⏏, ◀◀, ▶▶, etc.) to find a suitable frame, then press ENTER to set.



You can also use the chapter and time search features (press **PLAY MODE**), and the **CM SKIP** buttons.

- 4 Select 'Exit' to return to the Edit screen.

### Erase Section

VR mode

Using this command you can delete a part of a title, ideal for cutting out the commercial breaks in a recording made from the TV.

- 1 Highlight the title containing the section you want to erase.
- 2 Select 'Edit' > 'Erase Section' from the command menu panel.
- 3 Highlight 'From' then use the playback controls (▶, ⏏, ◀◀, ▶▶, etc.) to find the start of the section to erase, then press ENTER.

The bar at the bottom of the screen indicates the current play position in the title. After pressing **ENTER**, a marker shows the start of the section.



- 4 Highlight 'To' then, in the same way, find the end of the section to erase, then press ENTER. After pressing **ENTER**, another marker indicates the end of the section, with the section itself marked in red.

- 5 Select 'Yes' to confirm, or 'No' to cancel, then press ENTER.

In the thumbnail viewer you can see a few seconds of video either side of the marked section to see how the edit will look.

- When editing VR mode Original content, you may not be able to erase very short sections (less than five seconds).

## Divide

**VR mode** *Play List only*

Use this command to divide a title into two.

- Highlight the title you want to divide.
- Select 'Edit' > 'Divide' from the command menu panel.
- Use the playback controls (▶, II, ◀◀, ▶▶, etc.) to find the place you want to divide the title.



- Press ENTER to divide the title at the current playback position.

## Chapter Edit

**VR mode**

When editing a VR mode DVD you can edit individual chapters within a title, with commands for erasing, combining and dividing.

- Highlight the title that contains the chapters you want to edit.
- Select 'Edit' > 'Chapter Edit' from the command menu panel.
- Select the command you want:
  - Divide** – Divide a chapter into two or more parts: Use the playback controls (▶, II, ◀◀, ▶▶, etc.) to find the point at which you want to divide the chapter, then press ENTER.

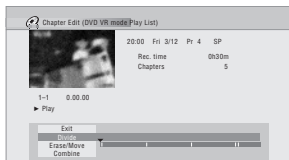

### Note

- When editing VR mode Original content, it may not be possible to erase chapters less than five seconds long.
- VR mode Play List only.
- It may not always be possible to combine two chapters, even though they are adjacent. If a chapter has been divided into three, then the middle chapter erased, it is not possible to combine the two remaining chapters into one.

You can keep dividing the chapter as many times as you wish (up to 999 chapters per DVD disc).

- Erase<sup>1</sup>/Move<sup>2</sup>** – Erase or move chapters: Select the chapter you want to erase/move and press ENTER. Select whether you want to erase or move the chapter.

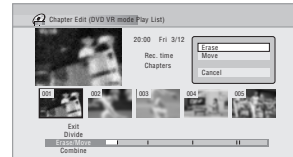

*Move command only:* Select the destination for the chapter, and press ENTER.

- Combine<sup>3</sup>** – Combine two adjacent chapters into one: Highlight the bar divider between two adjacent chapters and press ENTER.

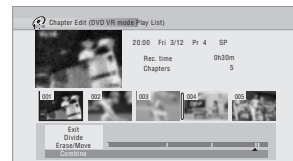

- Select 'Exit' to get back to the main Disc Navigator screen.

## Lock

**Video mode** **VR mode** *Original only*

You can lock a title so that it can't be edited or erased accidentally. If you do need to edit it, you can always unlock it later.

### Important

- You can't undo any edits made before changing the lock status. You also can't undo a lock/unlock command using the **Undo** option from the Disc Navigator menu.

- Highlight the title you want to lock (or unlock).

2 Select 'Edit' > 'Lock' from the command menu panel.

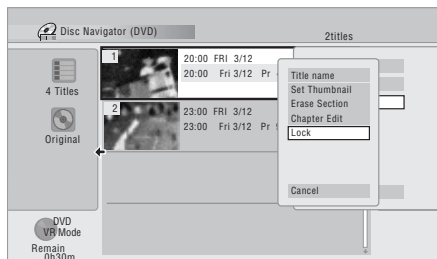

An unlocked title will become locked; a locked title will be unlocked. Locked titles are shown in the Disc Navigator with a padlock icon.

### Move

**VR mode** *Play List only*

Use this function to re-arrange the playing order of Play List titles.

- 1 Highlight the title you want to move.
- 2 Select 'Edit' > 'Move' from the command menu panel.

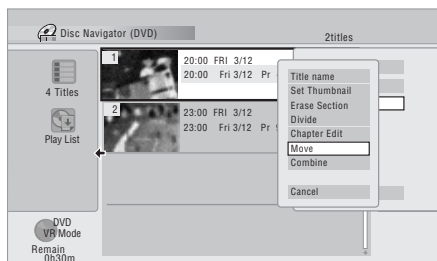

3 Select a new position in the Play List for the title, then press ENTER.

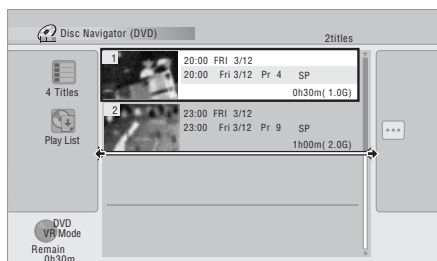

After pressing **ENTER**, the new, updated Play List is displayed.

### Combine

**VR mode** *Play List only*

Use this function to combine two Play List titles into one.

- 1 Highlight the title you want to combine. This title will remain in the same place after combining with another title.
- 2 Select 'Edit' > 'Combine' from the command menu panel.

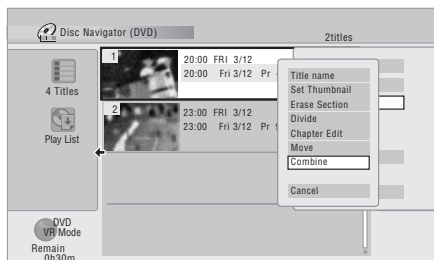

- 3 Select another title to combine with the first. This title will be appended to the first title selected. After pressing **ENTER**, the new, updated Play List is displayed.



## Undo

**Video mode** **VR mode**

If you make a mistake while editing, you can generally undo it. There are three levels of undo (in other words, you can undo the last three edits you made).

### 1 Select 'Undo' from the command menu panel.

- You can't undo anything after exiting the Disc Navigator screen.

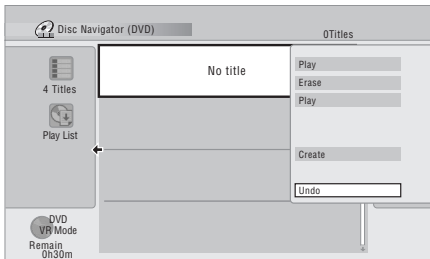

### Frequently asked questions

- Why doesn't the available recording time increase when I erase titles from a VR mode DVD-R?*

When you erase titles from a DVD-R, the titles are no longer displayed, but the content remains on the disc. DVD-R is a write-once medium; it can't be erased or rewritten.

- I can't edit my disc!*

You may find that as the available recording time is reduced on a VR mode DVD-R disc, editing is no longer possible. This is because information about your edits requires a certain amount of disc space. As you edit, this information builds up, eventually preventing you from editing further.

## Chapter 8

# The PhotoViewer

From the PhotoViewer you can view JPEG photos and picture files stored on a CD-ROM/R/RW<sup>1</sup> on your TV.

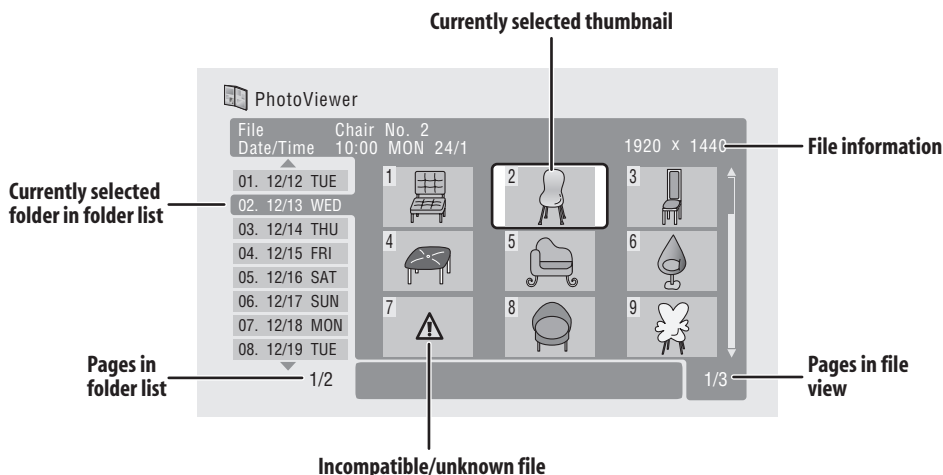

### Playing a slideshow

#### 1 Press HOME MENU and select 'PhotoViewer' to display the PhotoViewer screen.

- The PhotoViewer is only accessible when a disc containing JPEG files is loaded.
- If you encounter a disc that will not play, check that the disc and file formats are compatible with this recorder (see *JPEG file compatibility* and *PC-created disc compatibility* on page 10).

#### 2 Use the ↑/↓ buttons to select a folder from the folder list.

The first nine images from the selected folder are displayed as thumbnails in the main part of the screen.

- The larger the file size, the longer it takes the recorder to load the file.

#### 3 Press ENTER or → to move to the thumbnail view area.

The first thumbnail image is highlighted.

- To get back to the folder list, press RETURN (or ← when the leftmost thumbnail is highlighted).

#### 4 Use the ↑/↓/←/→ to select a thumbnail.

- Use the I◀◀ and ▶▶I buttons to display the previous/next page of thumbnails.

#### 5 Press ENTER or ► PLAY to start playing a slideshow from the selected thumbnail.

- Use the I◀◀ PREV / NEXT ▶▶I buttons to display the previous/next picture, or the II PAUSE button to pause the slideshow.
- Depending on the aspect ratio, some pictures may be displayed with black bars top and bottom, or left and right.
- Large picture files may take a few seconds to display. This is normal.

#### 6 Press ■ STOP or RETURN to return to the thumbnail view area.

#### 7 To return to the folder view area, press RETURN (or ← when the leftmost thumbnail is highlighted).

- To exit the PhotoViewer, press HOME MENU.

#### Note

1. Up to 999 files or 99 folders are viewable, but if there are more files/folders than this on the disc it is still possible to view them all using the Reload function (see the following page).

### Reloading files from a disc

If you have a disc with a large number of files and/or folders, you can still view all the images using the reload function.

**1 Use the ↓ button to navigate to the last entry in the folder list ('Read next: ...').**

**2 Press ENTER to load the next batch of up to 999 files/99 folders from the disc.**

It will take a moment (at most a minute) to load in the images.<sup>1</sup>

### Zooming the image

During a slideshow you can zoom in to enlarge a portion of the picture by a factor of two or four. You can also move the area of the picture displayed.

**1 During a slideshow, use the CH + button to zoom the picture.**

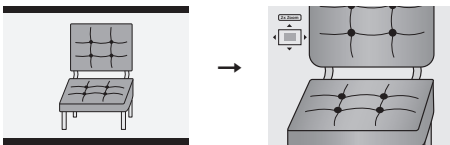

Repeated presses cycle between zoom off, 2x zoom and 4x zoom. The zoom factor is displayed on-screen.

**2 Use the ↑/↓/←/→ to move the zoomed area within the picture.**

### Rotating an image

You can rotate the displayed picture during a slideshow so you can always view pictures the right way up, whichever way they were taken.

**• During a slideshow, press ANGLE to rotate the displayed picture clockwise by 90°.**

Press **ANGLE** repeatedly to continue rotating the picture in increments of 90°.



#### Note

<sup>1</sup>You can press **HOME MENU** to exit the PhotoViewer screen while the recorder is reloading images. (If you enter the PhotoViewer again, it will resume reloading.)

# Chapter 9 The Disc Setup menu

## Introduction

From the Disc Setup menu you can name discs, lock the contents to prevent accidental recording and erasure, initialize and finalize discs. The Disc Setup menu is accessed from the Home menu:

- Press **HOME MENU** and select 'Disc Setup'.

## Basic settings

### Input Disc Name

**VR mode** **Video mode**

When you initialize a disc for recording, the recorder automatically assigns a name for the disc ranging from **DISC 1** to **DISC 99**. You can use the Input Disc Name function<sup>1</sup> to change the default disc name to something more descriptive. This name appears when you load the disc and when you display disc information on-screen.

- 1 Select 'Input Disc Name' from the Basic options, then 'Next Screen'.

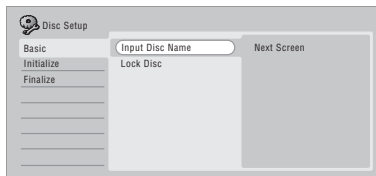

- 2 Input a name for the disc up to 64 characters long for a VR mode disc, or 40 for a Video mode disc.

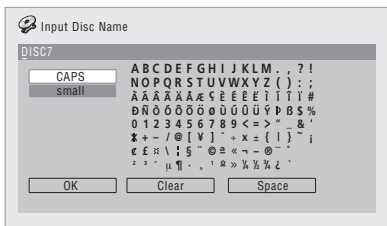

- Use the **↑/↓/←/→** and **ENTER** to select characters.

### Note

1. You cannot input a name for a disc if the TV line system of the disc is different to the current setting of the recorder. See *Additional information about the TV system settings* on page 74 for how to change the recorder's setting.
2. You cannot change the lock setting for a disc if the TV line system of the disc is different to the current setting of the recorder. See *Additional information about the TV system settings* on page 74 for how to change the recorder's setting.

- Use the **◀◀/▶▶** buttons to change the cursor position.
- Select **CAPS** or **small** to change to upper or lower-case, or use the **CASE SELECTION** buttons (**◀◀/▶▶**).
- You can also use the **CLEAR** button to delete characters directly (press and hold for two seconds to delete the whole name). For other remote control key shortcuts, see *Using the remote key shortcuts to input a name* on page 56.
- For discs formatted on a different DVD recorder, you will see only a limited character set.

### Lock Disc

**VR mode**

- Default setting: **Off**

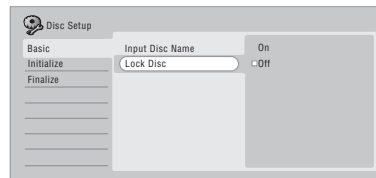

Set to **On** to prevent accidental recording, editing or erasing of the disc loaded<sup>2</sup>. If you need to unlock the disc to make edits, select **Off**.

### Important

- A locked disc can still be initialized (which will completely erase the disc).

---

## Initialize settings

DVD-R DVD-RW

You can initialize a recordable DVD disc for either VR mode or Video mode recording.

The first time you load a new DVD-RW disc, it will be automatically initialized for recording according to the DVD-RW Auto Init. setting in the Initial Setup menu (see page 72).

New DVD-R discs are ready for Video mode recording when you load them, but it is also possible to initialize them for VR mode recording.

The initialize menu here lets you reinitialize a disc, for example if you want to change the recording format of the disc. See *Initializing a recordable DVD disc* on page 45 for detailed instructions.

---

## Finalize settings<sup>1</sup>

### Finalize

DVD-R DVD-RW

Finalizing 'fixes' the recordings in place so that the disc can be played on a regular DVD player or computer equipped with a suitable DVD-ROM drive.

See *Playing your recordings on other DVD players* on page 44 for detailed instructions.

### Undo Finalize

DVD-RW

You can undo the finalization on DVD-RW discs recorded on this recorder in Video mode. You need to do this if you want to record more material or edit material already on the disc.

You can also undo the finalization of VR mode discs which have been finalized on other DVD recorders. If when you load a disc the message **This disc cannot be recorded. Undo the finalization** is displayed, use this command to be able to record on the disc using this recorder.

**1 From the Disc Setup menu, select 'Finalize', then 'Undo Finalize' from the finalize options.**

**2 Select 'Start'.**

---

#### Note

1.You cannot finalize a disc or use the Undo Finalize command if the TV line system of the disc is different to the current setting of the recorder. See *Additional information about the TV system settings* on page 74 for how to change the recorder's setting.



Chapter 10

# The Video/Audio Adjust menu

Using the Video/Audio Adjust menu you can set up the picture quality for the built-in tuner and external inputs, for disc playback, and for recording.

## Setting the picture quality for TV and external inputs

Picture Creation lets you choose a set of picture quality settings for the built-in TV tuner and for each external input. There are several preset settings that suit various sources, or you can create up to three of your own sets.

### Choosing a preset

1 With the recorder stopped, press HOME MENU and select 'Video/Audio Adjust'.



2 Select 'Video Adjust'.

3 Use the ←/→ buttons to change the preset.

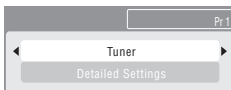

- Use the **INPUT SELECT** button to switch between the built-in TV tuner and the external inputs.
- Use the **CH +/-** buttons to change the channel of the built-in TV tuner.

There are six presets available:

- **Tuner** – suitable for general TV broadcasts
- **VCR** – suitable for video cassettes
- **LDP** – suitable for Laserdiscs
- **Memory1** – user preset 1
- **Memory2** – user preset 2
- **Memory3** – user preset 3

You can press **DISPLAY** to see the individual settings for the current preset (**Tuner**, **VCR** or **LDP**).

4 Press **ENTER** to select the preset.

### Creating your own set

There are three user presets in which you can save your own set of picture quality settings.

1 Follow *Choosing a preset* above and select one of the user presets (**Memory 1, 2 or 3**).

2 Select 'Detailed Settings'.

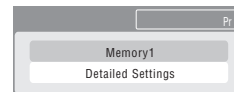

3 Use the ↑/↓ buttons to select the picture quality setting you want to adjust.

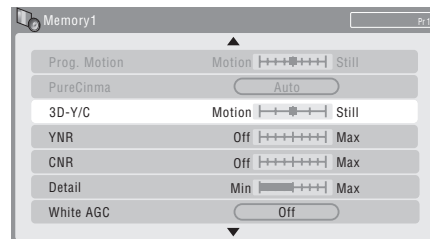

You can adjust the following settings:<sup>1</sup>

- **Prog. Motion** – Adjusts the motion and still picture quality when video output is set to progressive.
- **PureCinema** – This setting optimizes the picture for film material when the video output is set to progressive. Usually this is best left set to **Auto**; try switching to **Off** if the picture appears unnatural.
- **3-D Y/C** – Adjusts the brightness/color separation (NTSC video only).
- **YNR** – Adjusts the amount of noise reduction (NR) applied to the Y (brightness) component.
- **CNR** – Adjusts the amount of noise reduction (NR) applied to the C (color) component.
- **Detail** – Adjusts how sharp edges appear.
- **White AGC** – Turn on for automatic white level adjustment.<sup>2</sup>

**Note**

1. When the DV input is selected, only **Prog. Motion** and **PureCinema** settings can be adjusted.
2. When **White AGC** is **On**, the **White Level** setting can't be adjusted.

- **White Level** – Adjusts the intensity of white.
- **Black Level** – Adjusts the intensity of black.
- **Black Setup** – Corrects the standard reference black level (NTSC video input only).
- **Gamma Correction** – Adjusts the brightness of darker images.
- **Hue** – Adjusts overall balance between red and green.
- **Chroma Level** – Adjusts how rich the colors appear.

4 Use the **←/→** buttons to adjust the currently selected picture quality setting.

5 When you have all the settings as you want them, press **HOME MENU** to exit.

You can now use the preset for any other input or the built-in TV tuner.



#### Tip

- To see more of the picture as you adjust different settings, press **ENTER** after selecting the setting you want to adjust.

## Setting the picture quality for disc playback

This setting determines how the picture will look when playing discs.

### Choosing a preset

- 1 With a disc playing (or paused), press **HOME MENU** and select 'Video/Audio Adjust'.
- 2 Select 'Video Adjust'
- 3 Use the **←/→** buttons to change the setting.

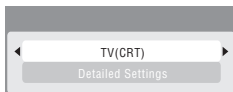

There are six presets available:

- **TV(CRT)** – suitable for standard cathode-ray tube TVs
- **PDP** – suitable for plasma display screens
- **Professional** – suitable for professional monitors
- **Memory1** – user preset 1
- **Memory2** – user preset 2
- **Memory3** – user preset 3

You can press **DISPLAY** to see the individual settings for the current preset (**TV(CRT)**, **PDP** or **Professional**).

- 4 Press **ENTER** to select the preset.

### Creating your own set

There are three user presets in which you can save your own set of picture quality settings for disc playback.

1 Follow *Choosing a preset* above and select one of the user presets (**Memory 1, 2 or 3**).

2 Move the cursor down and select 'Detailed Settings'.

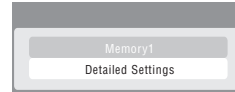

3 Select the picture quality setting you want to adjust.

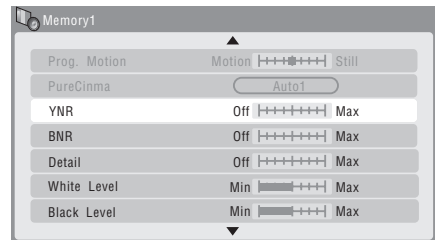

You can adjust the following settings:

- **Prog. Motion** – Adjusts the motion and still picture quality when video output is set to progressive.
- **PureCinema** – This setting optimizes the picture for film material when the video output is set to progressive. Usually this is best left set to **Auto 1**; try switching to **Auto 2**, **On** or **Off** if the picture appears unnatural.
- **YNR** – Adjusts the amount of noise reduction (NR) applied to the Y (brightness) component.
- **BNR** – Adjusts the amount of noise reduction (NR) applied to the block noise (artefacts visible in areas of flat color, caused by MPEG compression).
- **Detail** – Adjusts how sharp edges appear.
- **White Level** – Adjusts the intensity of white.

- **Black Level** – Adjusts the intensity of black.
- **Black Setup** – Corrects the standard reference black level (NTSC video playback only).
- **Gamma Correction** – Adjusts the brightness of darker images.
- **Hue** – Adjusts overall balance between red and green.
- **Chroma Level** – Adjusts how rich the colours appear.

**4 Use the ←/→ buttons to adjust the currently selected picture quality setting.**

**5 When you have all the settings as you want them, press HOME MENU to exit.**



### Tip

- To see more of the picture as you adjust different settings, press **ENTER** after selecting the setting you want to adjust.

## Audio DRC

- Default setting: **Off**

When watching Dolby Digital material at low volume, it's easy to lose low level sounds completely—including some of the dialog. Switching on Audio DRC (Dynamic Range Control) can help by bringing up the low level sounds, while controlling high level peaks.

- 1 During playback or when paused, press HOME MENU and select 'Video/Audio Adjust'.**
- 2 Select 'Audio Adjust'.**
- 3 Use the ←/→ buttons to adjust DRC from 'Off' to 'Max'.**



Exactly how much difference you can hear between the settings will depend on the material.



### Tip

- Audio DRC is not effective when listening to a disc via the digital output when **Dolby Digital Out** is set to **Dolby Digital**. In this case adjust the dynamic range from your AV amplifier/receiver.

## Chapter 11

## The Initial Setup menu

## Using the Initial Setup menu

The Initial Setup menu is where you can set various recorder options for sound, picture, language and so on.

Some settings can only be changed when the recorder is stopped. During playback and recording these settings are grayed out in the Initial Setup menu.

Except for the Setup Navigator, menu screens are exited automatically after 20 minutes of inactivity.

- Press **HOME MENU** and select 'Initial Setup'.

In the table below, the default option is marked with a •.



## Tip

- Some of the Initial Setup menu screens shown in this section vary slightly depending on the country or region of purchase.

Setting	Options	Explanation
<b>Basic Settings</b>		
<b>Clock Setting</b>	<b>Auto</b>	Set the channel that broadcasts a clock signal and the clock will be set automatically.
	<b>Manual •</b>	If there is no channel that broadcasts a clock signal in your area, you can set the time and date manually.
	<b>Display</b>	Set preferences for time and date display format.
<i>The clock must be set in order to use timer recording.</i>		
<b>Input Line System</b>	<b>525 System</b>	Use for NTSC or PAL-60 recording from an external input.
	<b>625 System •</b>	Use for standard PAL or SECAM recording.
<i>See also About the input line system on page 74 for more information on this setting.</i>		
<b>Power Save</b>	<b>On</b>	No antenna input signals are passed through to the outputs when the recorder is in standby.
	<b>Off •</b>	When the recorder is in standby, all signals arriving at the antenna inputs are passed along to the outputs.
<b>Help Setting</b>	<b>On •</b>	Switches on the automatic Help screens for GUI displays.
	<b>Off</b>	Switches off the automatic Help screens for GUI displays. (Press <b>HELP</b> on the remote to manually display the Help screen.)
<b>Setup Navigator</b>	<b>Start</b>	Select to start the Setup Navigator. See also <i>Switching on and setting up</i> on page 23.
<b>Tuner Settings</b>		
<b>Auto Channel Setting</b>	<b>Next Screen</b>	Proceed to the next screen, select select your country, then wait for automatic tuning to complete. The channel mapping screen should appear when the recorder is set up. Press <b>ENTER</b> to exit this screen.

Setting	Options	Explanation
<b>Manual CH Setting</b>	<b>Next Screen</b>	<p>Proceed to the next screen if you need to adjust any of the settings made by auto tuning. Select your country, then proceed to the manual channel setting screen:</p> <ul style="list-style-type: none"> <li>• Change channel presets using the <b>CH +/-</b> buttons.</li> <li>• To skip the displayed channel (because there is no station assigned to that channel), change the <b>Skip</b> setting to <b>On</b>.</li> <li>• Set the <b>CH SYSTEM</b> setting to match the channel system of your country or region.</li> <li>• Set the <b>CHANNEL</b> setting to the channel you want to assign to the current channel preset.</li> <li>• To manually fine tune the channel, change the <b>AFT</b> setting to <b>Off</b> then adjust the <b>Level</b> setting.</li> <li>• The <b>Name</b> field allows you to input a name of up to five characters for the current channel preset.</li> </ul>
<b>Channel Swapping</b>	<b>Next Screen</b>	<p>Proceed to the next screen to swap channel assignments of different presets so that you can group together presets that naturally go together. Select two presets to swap then press <b>ENTER</b>.</p>
<b>G-Code CH Setting</b>	<b>Next Screen</b>	<p>Proceed to the next screen to assign channel numbers to the guide channels as necessary. Look in your TV guide to see which channel numbers should be assigned to which guide channels. Press <b>ENTER</b> when your done to leave this screen.</p>

### Video In/Out Settings

<b>Input Colour System</b>	<b>Next Screen</b>	<p>Proceed to the next screen to set the input colour system for each channel preset. Use the <b>CH +/-</b> buttons to change the preset. On the default <b>Auto</b> setting the recorder can generally correctly detect whether the input signal is PAL, SECAM, 3.58 NTSC or PAL-60, but in some cases you may have to set it manually if the picture is displayed incorrectly.</p>
----------------------------	--------------------	--

See also About the input colour system on page 74 for more information on this setting.

<b>Component Video Out</b>	<b>Interlace •</b>	Select if your monitor/TV is not compatible with progressive-scan video.
	<b>Progressive</b>	Select if your monitor/TV is progressive-scan compatible. Check the operating instructions that came with your monitor/TV if you're not sure.
<b>NTSC on PAL TV</b>	<b>On</b>	NTSC discs will play correctly on PAL-only TVs.
	<b>Off •</b>	Use if your TV is already NTSC-compatible.

Many recent PAL TVs are compatible with NTSC input and so this setting can be switched off. Check the operating instructions that came with your TV. See also About NTSC on PAL TV on page 74 for related information.

### Audio In Settings

<b>Nicam Select</b>	<b>NICAM •</b>	Record the NICAM audio in a NICAM broadcast.
	<b>Regular Audio</b>	Record the non-NICAM audio in a NICAM broadcast. (You can still switch the audio to record using the <b>AUDIO</b> button before recording.)
<b>Tuner Level</b>	<b>Normal •</b>	Standard setting.
	<b>Compression</b>	Use if the audio level from the built-in tuner is excessive, causing distortion.

Setting	Options	Explanation
<b>External Audio</b>	<b>Stereo •</b>	Select if the audio from the currently selected external input is standard stereo.
	<b>Bilingual</b>	Select if each channel carries a separate soundtrack.
<i>When the external audio is from the DV input, an audio subcode channel within the DV audio tells the recorder whether the audio is stereo or dual mono. This has priority over the setting you make here.</i>		
<b>Bilingual Recording</b>	<b>A/L •</b>	Record the left (A) channel of a bilingual source when recording to DVD in Video mode or in <b>LPCM</b> mode, from an external source.
	<b>B/R</b>	As above, but for right (B) channel recording.
<i>When recording dual mono audio to DVD in VR mode (except in <b>LPCM</b> mode), both audio channels are recorded and you can switch to the one you want on playback.</i>		
<b>DV Input</b>	<b>Stereo 1 •</b>	Select to use the 'live' audio track (recorded during the video shoot) from a camcorder that supports two stereo audio tracks.
	<b>Stereo 2</b>	Select to use the overdubbed audio track from a camcorder that supports two stereo audio tracks.
	<b>Mix</b>	Select one of the three settings to use a mix of the two stereo audio tracks.
<b>Input Level (L1–L3)</b>	<b>-6dB – +6dB</b> <i>(default: 0 dB)</i>	Adjust the input level separately for each of the external inputs from -6dB to +6dB in steps of 3dB.
<b>Audio Out Settings</b>		
<b>Digital Out</b>	<b>On •</b>	Activates the digital audio output.
	<b>Off</b>	Deactivates the digital audio output.
<i>When set to <b>Off</b>, all the following Audio Out settings are grayed out.</i>		
<b>Dolby Digital Out</b>	<b>Dolby Digital •</b>	Output a Dolby Digital signal when a Dolby Digital source is being played.
	<b>Dolby Digital → PCM</b>	Convert Dolby Digital sources to Linear PCM output. Use if your connected equipment doesn't have a Dolby Digital decoder.
<b>DTS Out</b>	<b>On •</b>	Output a DTS signal when a DTS source is being played.
	<b>Off</b>	Switch off the digital output when a DTS source is being played. Use when your connected equipment doesn't have a DTS decoder. In this case, use the analog audio outputs.
<b>96 kHz PCM Out</b>	<b>96 kHz → 48 kHz •</b>	Convert 96 kHz digital audio sources to 48 kHz output. Use if your connected equipment doesn't support 96 kHz sampling rate.
	<b>96 kHz</b>	Output 96 kHz digital audio when a 96 kHz source is being played.
<b>MPEG Out</b>	<b>MPEG</b>	Output an MPEG audio signal when a source using MPEG audio is being played.
	<b>MPEG → PCM •</b>	Convert sources with MPEG audio to Linear PCM output. Use if your connected equipment doesn't have an MPEG audio decoder.
<b>Language Settings</b>		
<b>OSD Language</b>	<b>English •</b>	Sets the language of the on-screen displays to English.
	<i>available languages</i>	Choose from the languages displayed for the on-screen displays.

Setting	Options	Explanation
<b>Audio Language</b>	<b>English •</b>	Sets the default audio language for DVD-Video playback to English.
	<i>available languages</i>	Choose from the languages displayed to set the default audio language for DVD-Video playback.
	<b>Other</b>	Select to set the default audio language to something other than the ones listed. See <i>Selecting other languages for language options</i> on page 74.
<i>Discs do not necessarily have audio in your selected language. Also, some discs override the Audio Language preference.</i>		
<b>Subtitle Language</b>	<b>English •</b>	Sets the default subtitle language for DVD-Video playback to English.
	<i>available languages</i>	Choose from the languages displayed to set the default subtitle language for DVD-Video playback.
	<b>Other</b>	Select to set the default subtitle language to something other than the ones listed. See <i>Selecting other languages for language options</i> on page 74.
<i>Discs do not necessarily have subtitles in your selected menu language. Also, some discs override the Subtitle Language preference.</i>		
<b>Auto Language</b>	<b>On •</b>	On this setting: <ul style="list-style-type: none"> <li>• DVD-Video discs whose main audio track is in your default language will play using that language, without subtitles.</li> <li>• Discs whose main audio track is not in your default language but that have a subtitle track in your default language will play the original audio track with subtitles.</li> </ul>
	<b>Off</b>	Select to play DVD-Video discs according to your audio and subtitle language preferences.
<i>For Auto Language to be effective, the Audio Language and Subtitle Language options must be set to the same language.</i>		
<b>DVD Menu Language</b>	<b>w/Subtitle Language •</b>	Sets the language of DVD-Video menus to the same as that set for the subtitle language.
	<b>English</b>	Sets the language of DVD-Video menus to English.
	<i>available languages</i>	Choose from the displayed languages to set the default language for DVD-Video menus.
	<b>Other</b>	Select to set the DVD menu language to something other than the ones listed. See <i>Selecting other languages for language options</i> on page 74.
<i>Discs do not necessarily have menus in your selected menu language.</i>		
<b>Subtitle Display</b>	<b>On •</b>	Select to have discs display subtitles according to your Subtitle Language and Auto Language preferences.
	<b>Off</b>	Select to switch off subtitle display.
	<b>Assist Subtitle</b>	Select to display special additional assistive subtitles, where available.
<i>Some discs may override these settings.</i>		

Setting	Options	Explanation
<b>Recording Settings</b>		
<b>Manual Recording</b>	<b>On (go to setup)</b>	All the standard recording modes, plus <b>MN1–32</b> and <b>LPCM</b> modes can be set.
	<b>Off •</b>	Just the standard recording modes ( <b>XP</b> , <b>SP</b> , <b>LP</b> , <b>EP</b> , <b>SLP</b> and <b>SEP</b> ) can be set.
<i>See also Manual recording modes on page 81 for detailed information on manual recording levels.</i>		
<b>Optimized Rec</b>	<b>On</b>	The recording quality of timer recordings is automatically adjusted to fit on to the selected media if it will not fit at the selected quality setting. If the recording will not fit even at <b>MN1</b> , then the recording will start at <b>MN1</b> and stop when all the available space is used up.
	<b>Off •</b>	When a timer recording is set that won't fit on to the selected media, the recording starts but is cut off when no more recording is possible.
<i>Optimized Rec will only compensate for the next scheduled timer recording if more than one is set.</i>		
<b>Set Thumbnail</b>	<b>0 seconds •</b>	Sets the default thumbnail picture in the Disc Navigator to the first frame of the title.
	<b>30 seconds</b>	Sets the default thumbnail picture to 30 seconds into the title.
	<b>3 minutes</b>	Sets the default thumbnail picture to 3 minutes into the title.
<b>Auto Chapter (Video)</b>	<b>No Separation</b>	Automatic chapter marking is switched off.
	<b>10 minutes •</b>	When recording in Video mode, chapter markers are inserted every 10 minutes.
	<b>15 minutes</b>	Chapter markers are inserted every 15 minutes.
<b>DVD-RW Auto Init.</b>	<b>VR Mode •</b>	Blank DVD-RW discs are initialized for VR mode recording when loaded into the recorder for the first time.
	<b>Video Mode</b>	Blank DVD-RW discs are initialized for Video mode recording.
<b>Playback Settings</b>		
<b>TV Screen Size</b>	<b>4:3 (Letter Box) •</b>	Select if you have a standard 4:3 TV and prefer the letter box format presentation for widescreen material.
	<b>4:3 (Pan &amp; Scan)</b>	Select if you have a standard 4:3 TV and prefer the pan and scan presentation for widescreen material.
	<b>16:9</b>	Select if you have a widescreen 16:9 TV. Your TV settings determine how 4:3 material will look.
<i>Selecting <b>4:3 (Letter Box)</b> or <b>4:3 (Pan &amp; Scan)</b> does not guarantee that all video material will be presented in that format as some discs override this setting.</i>		
<b>Still Picture</b>	<b>Field</b>	Produces a stable, generally shake-free image.
	<b>Frame</b>	Produces a sharper image, but more prone to shake than Field stills.
	<b>Auto •</b>	The recorder automatically selects Field or Frame type still, according to the material playing.
<b>Seamless Playback</b>	<b>On</b>	Playback is smooth, but with a trade-off against the accuracy of the edit points.
	<b>Off •</b>	You may notice momentary interruption at edited points during playback of a VR mode Play List.



Setting	Options	Explanation
<b>Parental Lock</b>	<b>Set Password</b>	In order to change the parental lock level or change the country/area code, set the password using this option. From the following screen, enter a four-digit number that will be your password.
	<b>Change Password</b>	In order to change the password, first enter your existing password and then a new one from the following screen.
	<b>Change Level</b>	From the following screen, first enter your password and then set a parental lock level.
	<b>Country/Area Code</b>	From the following screen, first enter your password and then set a country/area code.
<i>Only certain discs have parental lock and country code features. Check the disc packaging to see what features the disc has. If you forget your password you can reset it by resetting the recorder to its factory settings. See Resetting the recorder on page 75.</i>		
<b>Angle Indicator</b>	<b>On •</b>	A camera icon appears on-screen during multi-angle scenes on a DVD-Video disc.
	<b>Off</b>	Nothing is indicated on-screen when a multi-angle scene is showing.
<b>Options</b>		
<b>On-Screen Display</b>	<b>On •</b>	The recorder displays operation displays ( <b>Stop</b> , <b>Play</b> , etc.) on-screen.
	<b>Off</b>	Switches off the on-screen operation displays.
<b>Front Panel Display</b>	<b>On •</b>	The time is shown in the front panel display when the recorder is in standby.
	<b>Off</b>	The front panel display is switched off in standby (although it still lights dimly when setting a timer recording).
<b>Remote Control Mode</b>	<b>Recorder 1–3</b> (default: Recorder 1)	If you are using more than one recorder in the same room, set them to different IDs. This setting sets the recorder ID; to change the remote controller ID, press and hold <b>RETURN</b> then press <b>1</b> , <b>2</b> or <b>3</b> to set. The remote will only control a recorder with the same ID.

## Additional information about the TV system settings

### About the input line system

This recorder is compatible with PAL, SECAM, 3.58 NTSC and PAL-60 TV systems. The Input Line System and Input Colour System settings determine how the recorder treats incoming video signals from an external input or the built-in TV tuner.

Please note the following points when changing the input line system:

- If, when the Input Line System setting is changed, the screen goes blank (due to incompatibility with your TV), you can switch back by pressing and holding the front panel **■ STOP** button then pressing **▲ OPEN/CLOSE** (also front panel) while the recorder is stopped.
- When you switch the Input Line System setting the Copy List is erased. If you switch the setting using the **■ STOP** button and **▲ OPEN/CLOSE** buttons as described above, there is no confirmation, so please use with care.
- You can't mix recordings of different TV line systems on the same disc.
- When you change this setting, the **Input Colour System** setting also changes (see below).

### About NTSC on PAL TV

Depending on the Input Line System setting and the NTSC on PAL TV setting, the signal format output when the recorder is stopped varies as shown in the table below.

Input Line System	NTSC on PAL TV	Output when stopped
625 System	Off	PAL
	On	PAL
525 System	Off	NTSC
	On	PAL-60

### About the input colour system

The available options of the Input Colour System setting depend on the Input Line System setting. The table below shows the different options available.

Input Line System	Built-in tuner	External input
625 System	Auto	Auto
	PAL	PAL
	SECAM	SECAM

Input Line System	Built-in tuner	External input
525 System	3.58 NTSC	Auto
		3.58 NTSC
		PAL-60

## Additional information about component video output

If you switch the Component Video Out setting to **Progressive** when using a TV that is not compatible with progressive-scan video, you will not be able to see anything displayed on your TV. If this happens, press and hold the **■ STOP** button on the front panel, then press **▶ PLAY**. This will set the recorder's video output back to Interlace.

### Compatibility of this unit with progressive-scan TVs

Consumers should note that not all high-definition television sets are fully compatible with this product and may cause artifacts to be displayed in the picture. In case of 525 progressive scan picture problems, it is recommended that the user switch the connection to the 'standard definition' output (**Interlace**). If there are questions regarding our TV set compatibility with this model, please contact our customer service center.

This recorder is compatible with the following Pioneer displays and monitors

### Plasma display

- PDP-503HDG, PDP-433HDG, PDP-504HDG, PDP-434HDG

## Selecting other languages for language options

### 1 Select 'Other' from the language list.

This option appears in the settings for DVD Menu Language, Audio Language, and Subtitle Language.

### 2 Select the language you want.

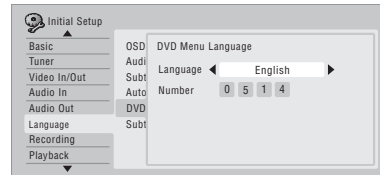

- Select by language name: Use the **←/→** buttons to change the language.
- Select by code number: Press **↓** then use the number buttons to enter the four-digit language code.

See *Language code list* on page 82 for a list of available languages and corresponding codes.

### 3 Press ENTER to confirm and exit the screen.

## Chapter 12

# Additional information

### Resetting the recorder

If you need to, you can reset the recorder to all its factory settings.

- 1 **Make sure that the recorder is on.**
- 2 **Press and hold ■ STOP and press ⏻ STANDBY/ON.**

The recorder turns off with all settings reset.

### Setting up the remote to control your TV

You can use the supplied remote to control your TV. To be able to use this feature you first have to program the remote with a maker code from the table below.

- 1 **Press and hold down the CLEAR button, then enter the maker code for your TV.**

The LED indicator on the remote controls lights.

See the table below for the list of maker codes. If there is more than one code given for your make, input the first one in the list.

- If the maker's name of your TV doesn't appear in the table below, you will not be able to use this remote to control your TV.

- 2 **Press ⏻ TV to check that the remote works with your TV.**

If the remote is set up correctly, the TV should switch on/off. If it doesn't and there is another code given for your maker, repeat step 1 with a new code.

### Using the TV remote control buttons







The table below shows how to use this remote control with your TV.

Button	What it does
⏻ TV	Press to switch the TV on/off (standby)
INPUT SELECT	Press to change the TV's video input
TV VOLUME	Use to adjust the TV volume
TV CHANNEL	Use to change TV channels





Maker	Code
Alba	66
Bush	76
Finlux	84
Fisher	61, 65
Fujitsu	77
Funai	67
Goldstar	79
Grandiente	87
Grundig	51, 82
Hitachi	56, 60, 83, 86
ITT	70
Mitsubishi	59
Nokia	53, 81
Panasonic	58, 72
Philips	57, 85
Pioneer	50, 80
RCA	68
Salora	71
Samsung	73, 75
Sanyo	74
Sei	78
Sharp	52
Sony	54
Tandy	69
Telefunken	64
Thomson	62
Toshiba	55
JVC	63

## Screen sizes and disc formats

### When viewing on a standard TV or monitor

Screen format of disc	Setting	Appearance
16:9 	4:3 (Letter Box) 	The program is shown in widescreen with black bars at the top and bottom of the screen.
	4:3 (Pan & Scan) 	The sides of the program are cropped so that the picture fills the whole screen.
4:3 	16:9 	The program appears squashed. Set to either <b>4:3 (Letter Box)</b> or <b>4:3 (Pan &amp; Scan)</b> .
	4:3 (Letter Box) 4:3 (Pan & Scan) 	The program is presented correctly on either setting.

### When viewing on a widescreen TV or monitor

Screen format of disc	Setting	Appearance
16:9 	16:9 	The program is presented in widescreen.
4:3 	16:9  	Your TV will determine how the picture is presented—check the manual that came with the TV for details.

## Troubleshooting

Incorrect operation is often mistaken for trouble and malfunction. If you think there is something wrong with this component, please check the points below. Sometimes the trouble may lie in another component. Investigate the other components and electrical appliances being used. If the trouble cannot be rectified even after checking the points below, ask your nearest Pioneer authorized service center or your dealer to carry out repair work.

### General

Problem	Remedy
<b>The disc is automatically ejected after closing the disc tray</b>	<ul style="list-style-type: none"> <li>• Check that the disc is not a DVD+R/RW, DVD-RAM or other incompatible format disc (page 9).</li> <li>• Check that the disc is loaded properly (aligned in disc tray and label-side up).</li> <li>• Take out the disc and clean it (page 84).</li> <li>• Check that the disc has a region code compatible with the recorder (page 87).</li> </ul>
<b>No picture</b>	<ul style="list-style-type: none"> <li>• Check that everything is connected properly (page 12).</li> <li>• Check that the connected TV and/or the AV amp/receiver is set to the correct input.</li> <li>• The recorder may be set to progressive scan with an incompatible TV. Reset to interlace by pressing and holding the front panel <b>■ STOP</b> button then pressing <b>▶ PLAY</b>.</li> </ul>
<b>Can't play a disc</b>	<ul style="list-style-type: none"> <li>• Check that the disc is a compatible format (page 9).</li> <li>• Take out the disc and clean it (page 84).</li> <li>• Check that the disc is loaded properly (aligned in disc tray and label-side up).</li> <li>• There may be condensation in the recorder. Leave the recorder for an hour or so for the condensation to evaporate.</li> </ul>
<b>Can't record a disc</b>	<ul style="list-style-type: none"> <li>• Check that the disc is not a DVD+R/RW, DVD-RAM or other incompatible format disc (page 9).</li> </ul>
<b>All settings are reset</b>	<ul style="list-style-type: none"> <li>• If the recorder is unplugged (or there is a power failure) while the recorder is on, all the settings will be lost.</li> <li>• Make sure that you switch the recorder into standby before unplugging the power cord.</li> </ul>
<b>Remote control does not work</b>	<ul style="list-style-type: none"> <li>• If you connected this recorder to another Pioneer product using the <b>CONTROL IN</b> jack, point the remote control at the other component to use (page 12).</li> <li>• Set the remote control to the same ID number as the recorder (page 73). (When the batteries run down, the remote mode is automatically reset to <b>Recorder1</b>.)</li> <li>• Use the remote within its operating range (page 8).</li> <li>• Replace the batteries (page 8).</li> </ul>
<b>No sound or sound is distorted</b>	<ul style="list-style-type: none"> <li>• Make sure that the amp/receiver or TV is set to the correct input and the volume turned up.</li> <li>• There is no sound when the picture is paused, or during scanning or slow motion play. Press <b>▶ PLAY</b> to resume regular playback.</li> <li>• DTS discs can only be played if this recorder is connected to a DTS decoder or DTS compatible amp/receiver. If you have connected a suitable decoder, also make sure that the <b>Initial Setup &gt; Audio Out &gt; DTS Out</b> setting is <b>On</b>.</li> <li>• Some 96kHz discs do not output audio through the digital jack. In this case, switch the input of your amp/receiver to analog.</li> <li>• Check the audio cable connections (page 12).</li> <li>• If the sound is distorted, try cleaning the cable plugs.</li> </ul>
<b>The picture from the external input is distorted</b>	<ul style="list-style-type: none"> <li>• If the video signal from the external component is copy-protected, you cannot connect via this recorder. Connect the component directly to your TV.</li> </ul>

Problem	Remedy
<b>The picture is distorted</b>	<ul style="list-style-type: none"> <li>Change the Input Line System setting (page 74). (You can also change it by pressing the <b>■ STOP</b> button and <b>▲ OPEN/CLOSE</b> on the front panel simultaneously with the recorder stopped.)</li> </ul>
<b>Screen is stretched vertically or horizontally</b>	<ul style="list-style-type: none"> <li>Make sure that the <b>TV Screen Size</b> setting (page 72) is correct for the kind of TV you have (see also page 76).</li> <li>If you have a widescreen TV, check its aspect ratio settings.</li> <li>This recorder's input switches into wide mode automatically according to the input signal. When the unit connected is not compatible with VIDEO ID-1 (widescreen signalling), set the connected component to output 4:3 aspect ratio (standard) video.</li> </ul>
<b>Can't play a disc recorded using this recorder on another player</b>	<ul style="list-style-type: none"> <li>If the disc was recorded in Video mode, make sure that it's finalized (page 44).</li> <li>Some players will not play recordable DVD discs, even when recorded in Video mode and finalized.</li> <li>If the disc was recorded in VR mode, the other player must be specifically RW compatible in order to play it (page 9).</li> <li>Discs recorded with copy-once material cannot be played on non-CPRM compatible players (page 33).</li> </ul>
<b>During playback the picture is dark or distorted</b>	<ul style="list-style-type: none"> <li>When a copy-protected disc is played via a VCR, the picture will not display correctly. Connect the recorder directly to your TV.</li> </ul>
<b>Can't control your TV using this remote control</b>	<ul style="list-style-type: none"> <li>If there is more than one code listed for your make of TV, try each one in turn (page 75).</li> <li>It is possible that none of the codes listed will work with your particular model of TV, even if the maker appears in the remote control code list.</li> </ul>
<b>Can't record or does not record successfully</b>	<ul style="list-style-type: none"> <li>Check that there is some remaining blank space on the DVD.</li> <li>For a Video mode disc, check that the disc isn't already finalized.</li> <li>One DVD disc may contain up to 99 (Original) titles and 999 chapters (VR mode), or 99 chapters (Video mode). Check that these limits have not been reached.</li> <li>Check that the source you are trying to record is not copy protected.</li> <li>For a VR formatted disc, check that the disc isn't locked (page 63).</li> <li>Check that you are recording with the same TV system (PAL, NTSC, etc.) as the disc has already been recorded in. All recordings on a disc must be in the same TV system.</li> <li>The power may have failed during recording.</li> </ul>
<b>Timer program doesn't record successfully</b>	<ul style="list-style-type: none"> <li>When setting the recording channel, make sure you set the recorder's built-in TV tuner, not the TV's built-in tuner.</li> <li>When recording to a Video mode disc, programs that are copy-once protected cannot be recorded. Use a VR mode formatted disc for copy-once material (page 33).</li> <li>Two timer programs may have overlapped, in which case only the earlier one will record completely.</li> <li>The power may have failed during recording.</li> <li>Check that the recorder's TV system (PAL, NTSC, etc.) settings are the same as the channel set for recording.</li> </ul>
<b>After briefly unplugging or after a power failure the front panel display shows '--:--'</b>	<ul style="list-style-type: none"> <li>A backup battery inside the recorder keeps the clock and other settings from being reset when there is no power to the recorder. This battery should last approximately five years from factory shipping. Reset the clock and other recorder settings to use the recorder again. To have the battery replaced, contact your dealer or a Pioneer Service Center.</li> </ul>
<b>Front panel display shows 'LOCK' when a button is pressed</b>	<ul style="list-style-type: none"> <li>The Child Lock is on; turn off in order to use the recorder (page 40).</li> </ul>

Problem	Remedy
<b>The picture freezes and the front panel and remote control buttons stop working</b>	<ul style="list-style-type: none"> <li>• Press <b>■ STOP</b> then try restarting playback.</li> <li>• Press the front panel <b>⏻ STANDBY/ON</b> button to switch the power off, then switch back on and restart playback. If the power fails to switch off, press and hold <b>⏻ STANDBY/ON</b> for 10 seconds until the power switches off.</li> </ul>

If the unit does not operate normally due to external effects such as static electricity, disconnect the power plug from the outlet and insert again to return to normal operating conditions.

## Frequently asked questions

In this section you can find answers to frequently asked questions on how to use your DVD recorder and what it can do..

- *What kind of discs can I use for recording?*

You can use DVD-R and DVD-RW discs for recording. DVD-RAM, CD-R and CD-RW discs are not recordable using this recorder.

See *Disc / content format playback compatibility* on page 9 for more details.

- *Can I watch recordings made using this recorder on other DVD players?*

Yes. Use a DVD-R disc for you recordings (these are always recorded in Video mode). After recording, finalize the disc to make it playable on other DVD players (note that you cannot make further recordings on the disc after finalizing it).

If you want to use a DVD-RW disc, make sure that it's initialized for recording in Video mode. As with a DVD-R, finalize the disc after recording to make it playable in other players.

See also *Playing your recordings on other DVD players* on page 44.

- *Can I edit recordings, or erase parts of recordings from a disc?*

Yes. Recording to a VR mode DVD-RW disc gives you the most flexibility when editing. By default, when you load a new DVD-RW disc into the recorder it is initialized for recording in VR mode.

See also *Editing* on page 54.

- *Can I play a VR mode DVD-RW disc in another DVD player?*

Look for the 'RW Compatible' mark on the other DVD player to see if it will play VR mode DVD-RW discs. If the player does not recognize the disc when you load it, try finalizing it in the recorder, then try again.

See also *Playing your recordings on other DVD players* on page 44.

- *Can I record a copy-once protected program from a subscription satellite or cable channel?*

Yes, but you'll need to use a CPRM-compatible DVD-RW disc initialized for VR mode recording. (Look on the disc package to see if it is CPRM compatible.)

See also *CPRM* on page 33.

- *Can I play a disc while recording?*

Yes. For simultaneous recording and playback, use a 2x speed compatible DVD-RW initialized for VR mode recording (the disc should be a DVD-RW Ver. 1.1 (CPRM-compatible), or Ver. 1.2).

See also *Simultaneous recording and playback* on page 40.

- *I changed the batteries in the remote control and now it doesn't work!*

Most likely the remote control ID does not match the recorder. After changing the batteries, the remote ID is reset to 1; if the recorder is set to something else, the remote will not work with it.

See *Remote Control Mode* on page 73 for how to set the ID of the recorder and the remote.

## About DV

Using DV, also known as i.LINK, you can connect a DV-equipped camcorder to this recorder using a single DV cable for input of audio, video, data and control signals.

The i.LINK interface is also known as IEEE 1394-1995.

"i.LINK" and the "i.LINK" logo are trademarks.

- This recorder is only compatible with DV-format (DVC-SD) camcorders. Digital satellite receivers and Digital VHS video recorders are not compatible.
- You cannot connect more than one DV camcorder at a time to this recorder.
- You cannot control this recorder from external equipment connected via the **DV IN** jack.
- It may not always be possible to control the connected camcorder via the **DV IN** jack.
- Digital camcorders can usually record audio as stereo 16-bit/48kHz, or twin stereo tracks of 12-bit/32kHz. This recorder can only record one stereo audio track. Set the **DV Input** setting as required (see *DV Input* on page 70).
- Audio input to the **DV IN** jack should be 32 or 48kHz (not 44.1kHz).
- Picture disturbance in the recording may occur if the source component pauses playback or plays an unrecorded section of tape, or if the power fails in the source component, or the DV cable becomes disconnected.
- The **DV IN** jack is an input only. There is no output functionality.

## DV-related messages

You may see the following messages appear on your TV screen when using the **DV IN** jack.

- **No DV camcorder connected.** – The camcorder is not connected properly, or the camcorder is switched off.
- **The DV camcorder is recording.** – The camcorder is recording, so you cannot start recording from the camcorder to this recorder.
- **You cannot connect more than one DV camcorder at the same time.** – The DV jack on this recorder supports connection to just one camcorder.
- **No tape in the DV camcorder.** – There is no cassette loaded into the connected equipment.
- **The DV camcorder is in record-pause mode.** – The camcorder is in record-pause mode.
- **DV camcorder playback canceled. Recording has been paused.** – Recording was paused because the camcorder is not in playback mode.
- **Cannot operate the DV camcorder.** – This recorder cannot control the camcorder. Try switching off the camcorder then switching it back on.
- **Could not operate the DV camcorder.** – This recorder was not able to control the camcorder.
- **Recording has stopped because the recorded material on the tape finished.** – When the recorded part of the DV tape comes to an end, this recorder automatically stops recording.
- **Recording has stopped because DV camcorder playback stopped.** – Recording stopped because DV camcorder playback was stopped or the camcorder was disconnected.
- **The DV camcorder is not set for playback. Please select playback mode on the DV camcorder.** – The camcorder is in camera mode.



## Manual recording modes

The table below shows the approximate recording times for a VR mode and Video mode DVD in each manual recording mode, as well as the standard recording mode equivalents. Levels separated by a bold line show where there is a noticeable change in picture quality.

Audio recording in all manual recording modes is in Dolby Digital 2ch format, except for LPCM mode, which is in Linear PCM format.

VR mode (DVD)				Video mode (DVD)		
Resolution*	Level	Rec. time		Level	Rec. time	Resolution*
352 x 240 / 352 x 288	MN 1	802 mins.		MN 1	802 mins.	352 x 240 / 352 x 288
	MN 2	720 mins.		MN 2	720 mins.	
	MN 3	600 mins.	<b>SEP</b>	MN 3	600 mins.	
	MN 4	480 mins.	<b>SLP</b>	MN 4	480 mins.	
	MN 5	420 mins.		MN 5	420 mins.	
	MN 6	360 mins.	<b>EP</b>	MN 6	360 mins.	
352 x 480 / 352 x 576	MN 7	300 mins.		MN 7	300 mins.	352 x 480 / 352 x 576
	MN 8	270 mins.		MN 8	270 mins.	
480 x 480 / 480 x 576	MN 9	240 mins.	<b>LP</b>	MN 9	240 mins.	
	MN 10	230 mins.		MN 10	230 mins.	
	MN 11	220 mins.		MN 11	220 mins.	
544 x 480 / 544 x 576	MN 12	210 mins.		MN 12	210 mins.	
	MN 13	200 mins.		MN 13	200 mins.	
	MN 14	190 mins.		MN 14	190 mins.	
	MN 15	180 mins.		MN 15	180 mins.	
720 x 480 / 720 x 576	MN 16	170 mins.		MN 16	170 mins.	
	MN 17	160 mins.		MN 17	160 mins.	
	MN 18	150 mins.		MN 18	150 mins.	
	MN 19	140 mins.		MN 19	140 mins.	
	MN 20	130 mins.		MN 20	130 mins.	
	MN 21	120 mins.	<b>SP</b>	MN 21	120 mins.	
	MN 22	110 mins.		MN 22	110 mins.	
	MN 23	105 mins.		MN 23	105 mins.	
	MN 24	100 mins.		MN 24	100 mins.	
	MN 25	95 mins.		MN 25	95 mins.	
	MN 26	90 mins.		MN 26	90 mins.	
	MN 27	85 mins.		MN 27	85 mins.	
	MN 28	80 mins.		MN 28	80 mins.	
	MN 29	75 mins.		MN 29	75 mins.	
	MN 30	70 mins.		MN 30	70 mins.	
	MN 31	65 mins.		MN 31	65 mins.	
	MN 32	61 mins.	<b>XP</b>	MN 32	61 mins.	
LPCM	61 mins.		LPCM	61 mins.		

\* The first figure refers to when the Input Line System is set to 525 System; the second when set to 625 System.

## Language code list

Language (Language code letter), **Language code**

Japanese (ja), <b>1001</b>	Bhutani (dz), <b>0426</b>	Kirghiz (ky), <b>1125</b>	Sinhalese (si), <b>1909</b>
English (en), <b>0514</b>	Esperanto (eo), <b>0515</b>	Latin (la), <b>1201</b>	Slovak (sk), <b>1911</b>
French (fr), <b>0618</b>	Estonian (et), <b>0520</b>	Lingala (ln), <b>1214</b>	Slovenian (sl), <b>1912</b>
German (de), <b>0405</b>	Basque (eu), <b>0521</b>	Laothian (lo), <b>1215</b>	Samoa (sm), <b>1913</b>
Italian (it), <b>0920</b>	Persian (fa), <b>0601</b>	Lithuanian (lt), <b>1220</b>	Shona (sn), <b>1914</b>
Spanish (es), <b>0519</b>	Finnish (fi), <b>0609</b>	Latvian (lv), <b>1222</b>	Somali (so), <b>1915</b>
Chinese (zh), <b>2608</b>	Fiji (fj), <b>0610</b>	Malagasy (mg), <b>1307</b>	Albanian (sq), <b>1917</b>
Dutch (nl), <b>1412</b>	Faroese (fo), <b>0615</b>	Maori (mi), <b>1309</b>	Serbian (sr), <b>1918</b>
Portuguese (pt), <b>1620</b>	Frisian (fy), <b>0625</b>	Macedonian (mk), <b>1311</b>	Siswati (ss), <b>1919</b>
Swedish (sv), <b>1922</b>	Irish (ga), <b>0701</b>	Malayalam (ml), <b>1312</b>	Sesotho (st), <b>1920</b>
Russian (ru), <b>1821</b>	Scots-Gaelic (gd), <b>0704</b>	Mongolian (mn), <b>1314</b>	Sundanese (su), <b>1921</b>
Korean (ko), <b>1115</b>	Galician (gl), <b>0712</b>	Moldavian (mo), <b>1315</b>	Swahili (sw), <b>1923</b>
Greek (el), <b>0512</b>	Guarani (gn), <b>0714</b>	Marathi (mr), <b>1318</b>	Tamil (ta), <b>2001</b>
Afar (aa), <b>0101</b>	Gujarati (gu), <b>0721</b>	Malay (ms), <b>1319</b>	Telugu (te), <b>2005</b>
Abkhazian (ab), <b>0102</b>	Hausa (ha), <b>0801</b>	Maltese (mt), <b>1320</b>	Tajik (tg), <b>2007</b>
Afrikaans (af), <b>0106</b>	Hindi (hi), <b>0809</b>	Burmese (my), <b>1325</b>	Thai (th), <b>2008</b>
Amharic (am), <b>0113</b>	Croatian (hr), <b>0818</b>	Nauru (na), <b>1401</b>	Tigrinya (ti), <b>2009</b>
Arabic (ar), <b>0118</b>	Hungarian (hu), <b>0821</b>	Nepali (ne), <b>1405</b>	Turkmen (tk), <b>2011</b>
Assamese (as), <b>0119</b>	Armenian (hy), <b>0825</b>	Norwegian (no), <b>1415</b>	Tagalog (tl), <b>2012</b>
Aymara (ay), <b>0125</b>	Interlingua (ia), <b>0901</b>	Occitan (oc), <b>1503</b>	Tswana (tn), <b>2014</b>
Azerbaijani (az), <b>0126</b>	Interlingue (ie), <b>0905</b>	Oromo (om), <b>1513</b>	Tonga (to), <b>2015</b>
Bashkir (ba), <b>0201</b>	Inupiak (ik), <b>0911</b>	Oriya (or), <b>1518</b>	Turkish (tr), <b>2018</b>
Byelorussian (be), <b>0205</b>	Indonesian (in), <b>0914</b>	Panjabi (pa), <b>1601</b>	Tsonga (ts), <b>2019</b>
Bulgarian (bg), <b>0207</b>	Icelandic (is), <b>0919</b>	Polish (pl), <b>1612</b>	Tatar (tt), <b>2020</b>
Bihari (bh), <b>0208</b>	Hebrew (iw), <b>0923</b>	Pashto, Pushto (ps), <b>1619</b>	Twi (tw), <b>2023</b>
Bislama (bi), <b>0209</b>	Yiddish (ji), <b>1009</b>	Quechua (qu), <b>1721</b>	Ukrainian (uk), <b>2111</b>
Bengali (bn), <b>0214</b>	Javanese (jw), <b>1023</b>	Rhaeto-Romance (rm), <b>1813</b>	Urdu (ur), <b>2118</b>
Tibetan (bo), <b>0215</b>	Georgian (ka), <b>1101</b>	Kirundi (rn), <b>1814</b>	Uzbek (uz), <b>2126</b>
Breton (br), <b>0218</b>	Kazakh (kk), <b>1111</b>	Romanian (ro), <b>1815</b>	Vietnamese (vi), <b>2209</b>
Catalan (ca), <b>0301</b>	Greenlandic (kl), <b>1112</b>	Kinyarwanda (rw), <b>1823</b>	Volapük (vo), <b>2215</b>
Corsican (co), <b>0315</b>	Cambodian (km), <b>1113</b>	Sanskrit (sa), <b>1901</b>	Wolof (wo), <b>2315</b>
Czech (cs), <b>0319</b>	Kannada (kn), <b>1114</b>	Sindhi (sd), <b>1904</b>	Xhosa (xh), <b>2408</b>
Welsh (cy), <b>0325</b>	Kashmiri (ks), <b>1119</b>	Sangho (sg), <b>1907</b>	Yoruba (yo), <b>2515</b>
Danish (da), <b>0401</b>	Kurdish (ku), <b>1121</b>	Serbo-Croatian (sh), <b>1908</b>	Zulu (zu), <b>2621</b>

## Country/Area code list

Country/Area, **Country/Area code**, **Code letter**

Argentina, <b>0118, ar</b>	Finland, <b>0609, fi</b>	Malaysia, <b>1325, my</b>	Singapore, <b>1907, sg</b>
Australia, <b>0121, au</b>	France, <b>0618, fr</b>	Mexico, <b>1324, mx</b>	Spain, <b>0519, es</b>
Austria, <b>0120, at</b>	Germany, <b>0405, de</b>	Netherlands, <b>1412, nl</b>	Sweden, <b>1905, se</b>
Belgium, <b>0205, be</b>	Hong Kong, <b>0811, hk</b>	New Zealand, <b>1426, nz</b>	Switzerland, <b>0308, ch</b>
Brazil, <b>0218, br</b>	India, <b>0914, in</b>	Norway, <b>1415, no</b>	Taiwan, <b>2023, tw</b>
Canada, <b>0301, ca</b>	Indonesia, <b>0904, id</b>	Pakistan, <b>1611, pk</b>	Thailand, <b>2008, th</b>
Chile, <b>0312, cl</b>	Italy, <b>0920, it</b>	Philippines, <b>1608, ph</b>	United Kingdom, <b>0702, gb</b>
China, <b>0314, cn</b>	Japan, <b>1016, jp</b>	Portugal, <b>1620, pt</b>	USA, <b>2119, us</b>
Denmark, <b>0411, dk</b>	Korea, Republic of, <b>1118, kr</b>	Russian Federation, <b>1821, ru</b>	

## On-screen displays and recorder displays

The table below shows a list of error messages that you may encounter when using the recorder and an explanation of their meaning.

Message	Explanation/Action
<ul style="list-style-type: none"> <li>• <b>Initializing disc. Please wait a moment.</b></li> </ul>	When you load a blank DVD-RW disc, the recorder automatically initializes it.
<ul style="list-style-type: none"> <li>• <b>Incompatible region number.</b></li> </ul>	The disc loaded has an incompatible region number for the recorder and so will not play.
<ul style="list-style-type: none"> <li>• <b>Cannot record any more titles.</b></li> <li>• <b>No more space for file management data.</b></li> <li>• <b>Cannot add any more chapter marks.</b></li> </ul>	The disc control data limit has been reached, or the maximum number of chapters and/or titles has been reached. Erase titles/chapters or combine chapters.
<ul style="list-style-type: none"> <li>• <b>This disc cannot be recorded. Undo the finalization.</b></li> </ul>	The disc was finalized on a non-Pioneer DVD recorder. Undo the finalization in order to recording/editing.
<ul style="list-style-type: none"> <li>• <b>Cannot play this disc.</b></li> <li>• <b>This disc cannot be recorded.</b></li> <li>• <b>Cannot read the CPRM information.</b></li> <li>• <b>Could not record the information to the disc.</b></li> <li>• <b>Cannot edit.</b></li> <li>• <b>Could not initialize disc.</b></li> <li>• <b>Could not complete finalization successfully.</b></li> <li>• <b>Could not undo finalization successfully.</b></li> <li>• <b>Could not successfully unlock the disc.</b></li> </ul>	The disc may be dirty or damaged. Take out the disc, clean it and retry. If the error persists, use a new disc. If the error appears even with a new disc, please consult a Pioneer Service Center.
<ul style="list-style-type: none"> <li>• <b>Incompatible or unreadable disc.</b></li> </ul>	The disc loaded is a DVD+R/RW, DVD-RAM or some other incompatible disc type. This display may also appear if the disc is dirty or damaged.
<ul style="list-style-type: none"> <li>• <b>Cannot record to a disc that is not CPRM compatible.</b></li> <li>• <b>Cannot record this content using Video mode recording.</b></li> </ul>	The video source is copy-once protected. Use a VR mode DVD-R/RW disc with CPRM for recording.
<ul style="list-style-type: none"> <li>• <b>This content is copy protected.</b></li> </ul>	The video source is copy-protected and cannot be recorded.
<ul style="list-style-type: none"> <li>• <b>Incorrect CPRM information.</b></li> </ul>	The recorder could not read the CPRM information. The recorder may be damaged—please consult a Pioneer Service Center.
<ul style="list-style-type: none"> <li>• <b>The audio will conform to the [Bilingual Recording] setting.</b></li> </ul>	When recording from an external input in Video mode, or in LPCM mode, you can only record the left or right channel; not both.
<ul style="list-style-type: none"> <li>• <b>Repairing disc.</b></li> </ul>	During recording, the power was cut. This display appears when the power is restored.
<ul style="list-style-type: none"> <li>• <b>Could not repair the disc.</b></li> </ul>	The recorder was unable to repair the disc after a power cut. The contents of the recording will be lost.
<ul style="list-style-type: none"> <li>• <b>Overheating has stopped operation. Press DISPLAY to clear this message.</b></li> </ul>	The internal temperature of the recorder has exceeded the operating limit. If this message reappears, please contact a Pioneer authorized service center.
<ul style="list-style-type: none"> <li>• <b>There is no DV input or the input signal is unrecordable.</b></li> <li>• <b>Cannot preview because there is no DV input or the input signal is unrecordable.</b></li> </ul>	No signal was detected at the <b>DV IN</b> jack. This may appear if a blank section of DV tape is playing in the connected camcorder.

Message	Explanation/Action
<ul style="list-style-type: none"> <li>• <b>This channel's TV system is different from the recorder's setting.</b></li> </ul>	The TV system (PAL, NTSC, etc.) of the current channel is different from the TV system settings of this recorder.
<ul style="list-style-type: none"> <li>• <b>Recording failed due to a TV system mismatch. Press DISPLAY to clear message.</b></li> </ul>	The timer recording failed because the TV system of the channel set for recording was different from the setting of the recorder.
<ul style="list-style-type: none"> <li>• <b>Playback has stopped because the TV system is different than the recording.</b></li> </ul>	During recording or timer recording standby, the TV System (PAL, NTSC, etc.) of the playback video changed, causing playback to stop automatically.

## Handling discs

When holding discs of any type, take care not to leave fingerprints, dirt or scratches on the disc surface. Hold the disc by its edge or by the center hole and edge.

Damaged or dirty discs can affect playback and recording performance. Take care also not to scratch the label side of the disc. Although not as fragile as the recorded side, scratches can still result in a disc becoming unusable.

Should a disc become marked with fingerprints, dust, etc., clean using a soft, dry cloth, wiping the disc lightly from the center to the outside edge. Don't clean discs with a circular motion.



If necessary, use a cloth soaked in alcohol, or a commercially available CD/DVD cleaning kit to clean a disc more thoroughly. Never use benzene, thinner or other cleaning agents, including products designed for cleaning vinyl records.

## Storing discs

Although CDs and DVD discs are more durable than vinyl records, you should still take care to handle and store discs correctly. When you're not using a disc, return it to its case and store upright. Avoid leaving discs in excessively cold, humid, or hot environments (including under direct sunlight).

Don't glue paper or put stickers onto the disc, or use a pencil, ball-point pen or other sharp-tipped writing instrument. These could all damage the disc.



For more detailed care information see the instructions that come with discs.

Do not load more than one disc into the recorder.

## Damaged discs

Discs spin at high speed inside the recorder. If you can see that a disc is cracked, chipped, warped, or otherwise damaged, don't risk using it; you could end up damaging the recorder.

This recorder is designed for use with conventional, fully circular discs only. Use of shaped discs is not recommended for this product. Pioneer disclaims all liability arising in connection with the use of shaped discs.

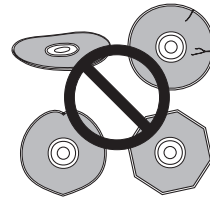

## Cleaning the pickup lens

The DVD recorder's lens should not become dirty in normal use, but if for some reason it should malfunction due to dust or dirt, consult your nearest Pioneer-authorized service center. Although lens cleaners for CD players are commercially available, we do not recommend using them since some may damage the lens.

## Condensation

Condensation may form inside the recorder if it is brought into a warm room from outside, or if the temperature of the room rises quickly. Although the condensation won't damage the recorder, it may temporarily impair its performance. For this reason you should leave it to adjust to the warmer temperature for about an hour before switching on and using.

## Hints on installation

We want you to enjoy using this unit for years to come, so please bear in mind the following points when choosing a suitable location for it:

### Do...

- ✓ Use in a well-ventilated room.
- ✓ Place on a solid, flat, level surface, such as a table, shelf or stereo rack.

### Don't...

- ✗ Use in a place exposed to high temperatures or humidity, including near radiators and other heat-generating appliances.
- ✗ Place on a window sill or other place where the recorder will be exposed to direct sunlight.
- ✗ Use in a dusty or damp environment or in a room where it will be exposed to excessive cigarette smoke.
- ✗ Place directly on top of an amplifier, or other component in your stereo system that becomes hot in use.
- ✗ Use near a television or monitor as you may experience interference—especially if the television uses an indoor antenna.
- ✗ Use in a kitchen or other room where the recorder may be exposed to smoke or steam.
- ✗ Use on a thick rug or carpet, or cover with cloth—this may prevent proper cooling of the unit.
- ✗ Place on an unstable surface, or one that is not large enough to support all four of the unit's feet.

## Moving the recorder

If you need to move the recorder, first remove the disc, if there's one loaded, and close the disc tray. Next, press **⏻** **STANDBY/ON** to switch the power to standby, checking that the **POWER OFF** indication in the display goes off. Wait at least two minutes. Lastly, disconnect the power cord. Never lift or move the unit during playback or recording—discs rotate at a high speed and may be damaged.

## Glossary

### Analog audio

An electrical signal that directly represents sound. Compare this to digital audio which can be an electrical signal, but is an indirect representation of sound. See also *Digital audio*.

### Aspect ratio

The width of a TV screen relative to its height. Conventional TVs are 4:3 (in other words, the screen is almost square); widescreen models are 16:9 (the screen is almost twice as wide as it is high).

### Chapter

Just as a book is split up into several chapters, a title on a DVD disc is usually divided into chapters. See also *Title*.

### Digital audio

An indirect representation of sound by numbers. During recording, the sound is measured at discrete intervals (44,100 times a second for CD audio) by an analog-to-digital converter, generating a stream of numbers. On playback, a digital-to-analog converter generates an analog signal based on these numbers. See also *Sampling frequency* and *Analog audio*.

### Dolby Digital



Dolby® Digital Recording enables consumers to record high-quality video with stereo sound on recordable DVD discs. The technology, when utilized instead of PCM recording, also saves recordable disc space, allowing for higher video resolution or extended recording time on each DVD. DVDs created using Dolby Digital Recording will play back on all DVD-Video players.

*Manufactured under license from Dolby Laboratories. "Dolby" and the double-d symbol are trademarks of Dolby Laboratories.*

**DRM (Digital Rights Management)**

DRM (Digital Rights Management) copy protection is a technology designed to prevent unauthorized copying by restricting playback, etc. of material on devices other than the PC (or other WMA recording equipment) used to record it. For detailed information, please see the instruction manuals or help files that came with your PC (or other WMA recording equipment) and/or software.

**DTS**

DTS stands for Digital Theater System. DTS is a surround system different from Dolby Digital that has become a popular surround sound format for movies.

*"DTS" and "DTS Digital Out" are registered trademarks of Digital Theater Systems, Inc.*

**Dynamic range**

The difference between the quietest and loudest sounds possible in an audio signal (without distorting or getting lost in noise). Dolby Digital and DTS soundtracks are capable of a wide dynamic range, delivering dramatic cinema-like effects.

**EXIF (Exchangeable Image File)**

A file format developed by Fuji Photo Film for digital still cameras. Digital cameras from various manufacturers use this compressed file format which carries date, time and thumbnail information, as well as the picture data.

**File extension**

A tag added to the end of a filename to indicate the type of file. For example, ".mp3" indicates an MP3 file.

**ISO 9660 format**

International standard for the volume and file structure of CD-ROM discs.

**JPEG**

A file format used for still images, such as photographs and illustrations. JPEG files are identified by the file extension ".jpg" or ".JPG". Most digital cameras use this format.

**MP3**

MP3 (MPEG1 audio layer 3) is a compressed audio file format. Files are recognized by their file extension ".mp3" or ".MP3".

**MPEG audio****MPEG ) ( Multichannel**

An audio format used on Video CDs and some DVD discs. This unit can convert MPEG audio to PCM format for wider compatibility with digital recorders and AV amp/receivers. See also *PCM*.

**MPEG video**

The video format used for Video CDs and DVDs. Video CD uses the older MPEG-1 standard, while DVD uses the newer and much better quality MPEG-2 standard.

**Optical digital output**

A jack that outputs digital audio in the form of light pulses. Connect components with optical digital jacks using a special optical cord, available from specialist audio dealers.

**PCM (Pulse Code Modulation)**

The most common system of encoding digital audio, found on CDs and DAT. Excellent quality, but requires a lot of data compared to formats such as Dolby Digital and MPEG audio. For compatibility with digital audio recorders (CD, MD and DAT) and AV amp/receivers with digital inputs, this unit can convert Dolby Digital and MPEG audio to PCM. See also *Digital audio*.

**PBC (PlayBack Control) (Video CD/Super VCD only)**

A system of navigating a Video CD/Super VCD through on-screen menus recorded onto the disc. Especially good for discs that you would normally not watch from beginning to end all at once—karaoke discs, for example.

**Progressive scan video**



Also called non-interlaced video, this method of displaying a picture updates all the lines in one pass, resulting in a more stable, flicker-free image than interlaced video (for a given scanning rate).

**PureCinema**

Video on a DVD disc may be either video material (originally shot on video) or film material (originally shot on film). Video material has a frame rate of 30 frames/second, compared to 24 frames/second for film. This recorder converts film material to 60 frames/second (in progressive scan mode). PureCinema adjusts the picture so that it matches more closely the picture quality of a cinema screen.

You can see whether video on a DVD disc is film or video material by displaying the transfer rate. If a '#' appears above the transfer rate display, it is film material.

**Regions (DVD-Video only)**

  (example region code marks)

Regions associate discs and players with particular areas of the world. This unit will only play discs that have compatible region codes. You can find the region code of your unit by looking on the rear panel. Some discs are compatible with more than one region (or all regions).

**Sampling frequency**

The rate at which sound is measured to be turned into digital audio data. The higher the rate, the better the sound quality, but the more digital information is generated. Standard CD audio has a sampling frequency of 44.1kHz, which means 44,100 samples (measurements) per second. See also *Digital audio*.

**Title**

A collection of chapters on a DVD disc. See also *Chapter*.

**Track**

Audio CDs and Video CDs use tracks to divide up the content of a disc. The DVD equivalent is called a chapter. See also *Chapter*.

**WMA**

WMA is short for Windows Media Audio and refers to an audio compression technology developed by Microsoft Corporation. WMA data can be encoded by using Windows Media Player version 9 or 10, or Windows Media Player for Windows XP. Files are recognized by their file extension “.wma” or “.WMA”.

Microsoft, Windows Media, and the Windows logo are trademarks, or registered trademarks of Microsoft Corporation in the United States and/or other countries.

## Specifications

### General

System	DVD-Video, DVD-R/RW, Video-CD, Super VCD, CD, CD-R/RW (WMA, MP3, JPEG, CD-DA)
Power requirements	110–127 / 220–240 V, 50/60 Hz
Power consumption	29 W
Power consumption in standby mode	0.67 W (Front panel display: off)
Weight	3.3 kg
Dimensions	420 (W) x 59 (H) x 273 (D) mm
Operating temperature	+5°C to +35°C
Operating humidity	.5% to 85% (no condensation)
TV system	PAL/SECAM/NTSC

### Recording

Recording format	DVD Video Recording DVD-VIDEO
------------------	----------------------------------

### Recordable discs

DVD-RW (DVD Re-recordable disc)
DVD-R (DVD Recordable disc)

### Video recording format

Sampling frequency	13.5MHz
Compression format	MPEG

### Audio recording format

Sampling frequency	48kHz
Compression format	Dolby Digital or Linear PCM (uncompressed)

### Recording time

#### DVD-R/DVD-RW

Fine (XP)	Approx. 1 hour
Standard Play (SP)	Approx. 2 hours
Long Play (LP)	Approx. 4 hours
Extended Play (EP)	Approx. 6 hours
Super Long Play (SLP)	Approx. 8 hours
Super Extended Play (SEP)	Approx. 10 hours
Manual Mode (MN)	Approx. 1–13 hours

## Tuner

### Receivable channels

	SECAM B/G PAL B/G		PAL I	
	Frequency	Channel	Frequency	Channel
<b>VHF (low)</b>	47 – 89 MHz	E2 – E4 X – Z	44 – 89 MHz	A – C X – Z
<b>VHF (high)</b>	104 – 300 MHz	E5 – E12 S1 – S20 M1 – M10 U1 – U10	104 – 300 MHz	D – J 11, 13 S1 – S20
<b>Hyper</b>	302 – 470 MHz	S21 – S41	302 – 470 MHz	S21 – S41
<b>UHF</b>	470 – 862 MHz	E21 – E69	470 – 862 MHz	E21 – E69

	SECAM D/K PAL D/K	
	Frequency	Channel
<b>VHF (low)</b>	49 – 94 MHz	R1 – R5
<b>VHF (high)</b>	104 – 300 MHz	R6 – R12 S1 – S20
<b>Hyper</b>	302 – 470 MHz	S21 – S41
<b>UHF</b>	470 – 862 MHz	E21 – E69

	NTSC-M/N	
	Frequency	Channel
<b>VHF</b>	55 - 218 MHz	2 – 13
<b>UHF</b>	471 – 808 MHz	14 – 69
<b>CATV</b>	72 – 806 MHz	C1 – C125

STEREO  
B/G - A2  
I - NICAM  
B/G - NICAM  
D/K - NICAM  
M/N - BTSC

## Timer

Programs	1 month/32 programs
Clock	Quartz lock (24-hour digital display)
Power off memory	Approx. 5 years (after manufacture)





# Index

## A

### Audio

- digital output settings **70**
- DV audio settings **43**
- dynamic range control **67**
- external audio settings **70**
- input settings **69**
- setting preferences for audio language **71**
- switching on playback **52, 53**
- switching TV audio **26**

Auto Start Recording **22, 42**

Automatic channel setup **23**

## C

### CD Audio

- compatibility **9**
- playback controls for **28, 48–52**

### Chapter

- automatic chapter marking **72**
- definition **85**
- editing **58**
- maximum number per title/disc **32**

CPRM **33**

## D

### Dolby Digital

- explained **85**
- output setting **70**

### DTS

- CD audio encoded with **28**
- explained **86**
- output setting **70**

### DV camcorder

- connecting **12, 18**
- error messages **80**
- recording from **42**
- setting the audio track to record **70**

### DVD

- activity display **30**
- aspect ratios **72, 76**
- compatibility **9, 32**
- DVD-R vs DVD-RW **9, 10, 32**
- finalizing **10, 44, 64**
- initializing **32, 64**
- playback controls for **28, 46–53**
- selecting for playback/recording **25**
- Video mode vs VR mode **9, 10, 32, 55, 64, 72**

## E

Easy Timer Recording **35**

Editing **54–60**

Video mode compatibility and frame accuracy **55**

Video mode vs VR mode **55**

## G

G-Code™ **36–37**

## J

### JPEG

- file compatibility **10**
- viewing in the PhotoViewer **61**

## L

### Language

- audio **52, 71**
- code list **82**
- DVD menu **71**
- setting for menus and displays (OSD) **70**
- settings for DVD playback **71**
- subtitle **71**

## M

MP3 audio files **9, 86**

MPEG audio **86**

## N

NTSC **22**

## P

### Picture quality

- recording time vs **32, 81**
- setting for playback **66**
- setting for recording **65**
- video connections and **14**

Playback **26–29, 46–53**

- on-screen displays **30**
- parental lock for DVD-Video **73**
- picture quality settings for **66**
- settings **72**

Progressive scan video **25**

## R

- Recording **25, 32–45**
  - audio format **33**
  - automatic chapter marking **72**
  - copyright and **33**
  - from a camcorder **42**
  - from an external input **41**
  - on-screen displays **31**
  - optimized **72**
  - settings **72**
  - simultaneous playback and **40**
  - time and picture quality **32, 81**
  - TV programs **25, 34**
  - Video mode vs VR mode **32**
- Remote control
  - buttons explained **20–21**
  - changing the batteries **8**
  - operating range **8**
  - setting the remote ID **73**
  - setting up for TV control **75**

## S

- Subtitles
  - setting preferences for **71**
  - switching during playback **52**

## T

- Timer recording **34–40, 42**
- Title
  - defined **87**
  - maximum number recordable **32**
  - thumbnails **57, 72**
- TV channels
  - automatic tuning **68**
  - changing **26**
  - manual setting **69**
  - numbering **26**

## V

- Video CD
  - compatibility **9**
  - playback control (PBC) **29, 46**
  - playback controls for **29, 48–52**

## W

- WMA audio files **9, 10, 87**

Published by Pioneer Corporation.  
Copyright © 2005 Pioneer Corporation.  
All rights reserved.

---

**PIONEER CORPORATION**

4-1, Meguro 1-Chome, Meguro-ku, Tokyo 153-8654, Japan

**PIONEER ELECTRONICS (USA) INC.**

P.O. BOX 1540, Long Beach, California 90810-1540, U.S.A. TEL: (800) 421-1404

**PIONEER ELECTRONICS OF CANADA, INC.**

300 Allstate Parkway, Markham, Ontario L3R 0P2, Canada TEL: (905) 479-4411

**PIONEER EUROPE NV**

Haven 1087, Keetberglaan 1, B-9120 Melsele, Belgium TEL: 03/570.05.11

**PIONEER ELECTRONICS ASIACENTRE PTE. LTD.**

253 Alexandra Road, #04-01, Singapore 159936 TEL: 656-472-1111

**PIONEER ELECTRONICS AUSTRALIA PTY. LTD.**

178-184 Boundary Road, Braeside, Victoria 3195, Australia, TEL: (03) 9586-6300

**PIONEER ELECTRONICS DE MEXICO S.A. DE C.V.**

Bldv.Manuel Avila Camacho 138 10 piso Col.Lomas de Chapultepec, Mexico,D.F. 11000 TEL: 55-9178-4270

**K002E**